

14H2052-150
 CE DINGS' MOTION
 RoHS DATE

REVISION			
REV.	DATE	DESCRIPTION	DRAWN BY

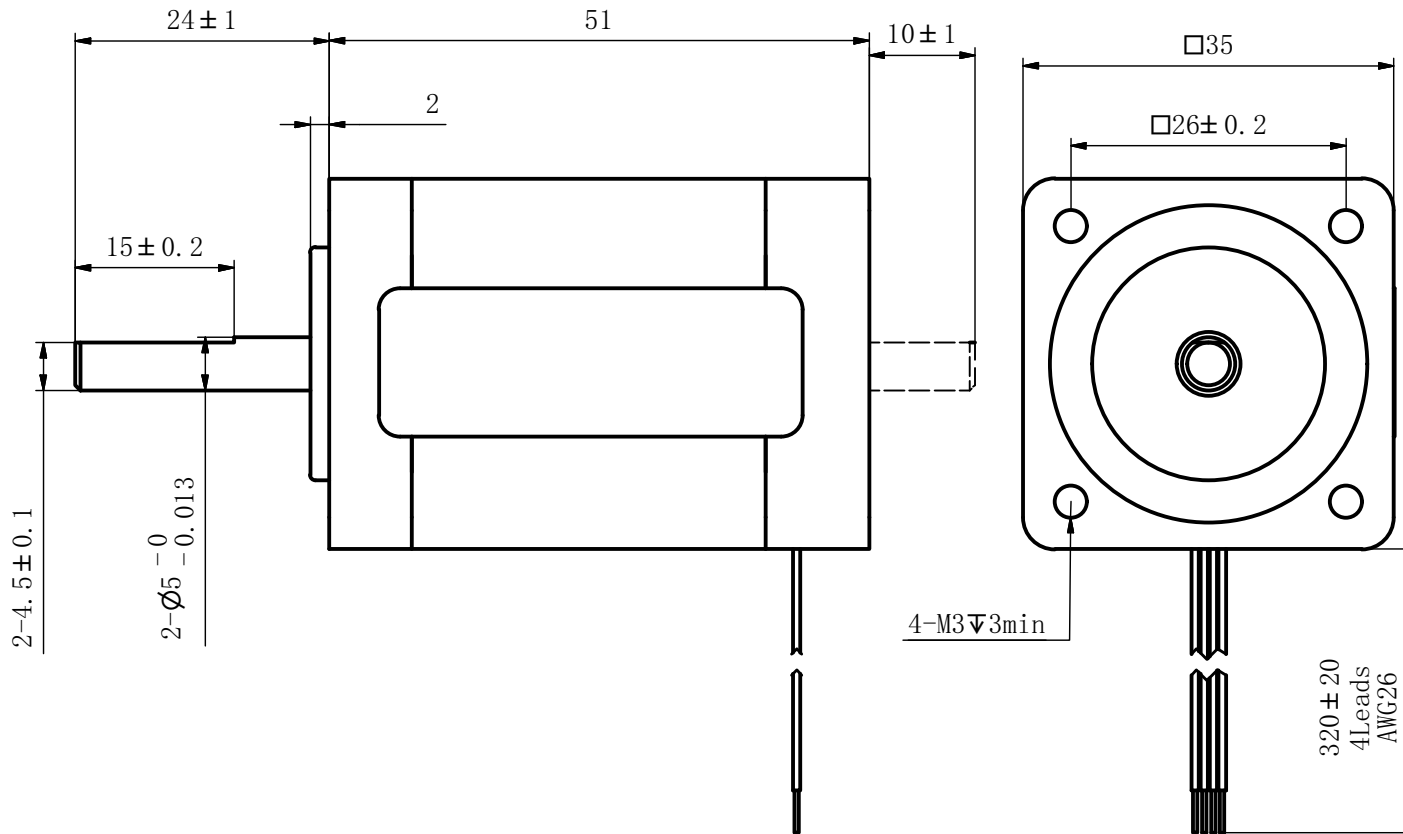

Motor's phase	2
Step angle	1.8°
Rated current/phase	1.5 A
Resistance/phase	3.2 Ω ±10%
Inductance/phase	4.5mH ±20%
Holding torque	0.35 N.m
Rotary inertia	36g.cm ²
Insulation class	B
Insulation resistance	100M Ω (500VDC)
Heat rise	80°C
Motor weight	0.3kg

CUSTOMER

NOTICE TO PERSONS RECEIVING THIS DRAWING
 THIS POSSESSION IS ONLY CONDITIONALLY ISSUED, AND FOR THE SOLE PURPOSE OF INFORMING LICENSEES AND ASSOCIATE CONTRACTORS OF DINGS' MOTION, AND VENDORS THERETO AND CUSTOMERS THEREOF, RECEIPT OR POSSESSION THEREOF DOES NOT CONFER TO TRANSFER ANY RIGHT IN THE SUBJECT MATTER OF THE DRAWING, THE DESIGN, CONSTRUCTION, TECHNICAL INFORMATION AND ALL OTHER SUBJECT MATTER SHOWN IN THIS DRAWING ARE AND REMAIN, EXCEPT AS MAY BE OTHERWISE INDICATED BY WRITTEN NOTICE HEREON, THE EXCLUSIVE PROPERTY OF SAID CORPORATION. THIS DRAWING MAY BE REPRODUCED ONLY BY LICENSEES AND ASSOCIATE CONTRACTORS OF SAID CORPORATION AND ONLY FOR LICENSED MANUFACTURE, AND BY VENDORS MANUFACTURING FOR SAID CORPORATION AND ONLY FOR LICENSEES AND ASSOCIATE CONTRACTORS.

WIRING CHART

EXCITING SEQUENCE

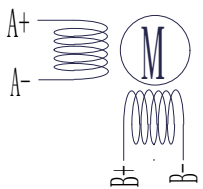

	→			
	+		-	
	-		+	
		+		-
		-		+
	←			

UNLESS OTHERWISE SPECIFIED ALL DIMENSIONS ARE IN MILLIMETERS AND TOLERANCES ARE AS BELOW PER ISO2768-cK.

LINEAR		ANGULAR	
0~3	±0.2	0~10	±1.5°
3~6	±0.5	10~50	±1°
6~30	±0.8	50~120	±30'
30~120	±1.5	120~400	±15'

DRAWN	DATE
APPRVD	DATE
MODEL	14H2052-150

DINGS'

SIZE	A3	SHEET	1 OF
SCALE	1: 1	REV	00