



VER 1.4

# Accessory Manual

**Stand Alone Stepper Electronics**

# Table of Contents

- 1. DS-CLS10-FRS4 (DS-CLS9-FCAO)..... 1
  - 1.1 Dimensional Drawing..... 1
  - 1.2 Accessories..... 1
    - (1) Power Extension Cable P1..... 1
    - (2) Motor Extension Cable P2..... 2
    - (3) Brake Extension Cable P3..... 2
    - (4) Encoder Extension Cable P4..... 3
    - (5) I/O Extension Cable P5..... 4
    - (6) RJ45 Communication Cable ② to Driver P6 or P7..... 5
- 2. DS-CLS9-FRS4-01 (DS-CLS9-FRS4)..... 6
  - 2.1 Dimensional Drawing..... 6
  - 2.2 Accessories..... 6
    - (1) Motor Extension Cable P1..... 6
    - (2) Encoder Extension Cable P2..... 7
    - (3) I/O Extension Cable P3..... 7
    - (4) RJ45 Communication Cable ① to RJ45 P4 or P5..... 9
    - (5) RJ45 Communication Cable ② to Driver P4 or P5..... 10
    - (6) USB to RJ45 Converter to PC..... 10
- 3. DS-OLS8-FRS4..... 11
  - 3.1 Dimensional Drawing..... 11
  - 3.2 Accessories..... 11
    - (1) RJ45 Communication Cable ① to RJ45 P1 or P2..... 11
    - (2) RJ45 Communication Cable ② to Driver P1 or P2..... 12
    - (3) USB to RJ45 Converter to PC..... 12
- 4. DS-OLS7-FRS4..... 13
  - 4.1 Dimensional Drawing..... 13
  - 4.2 Accessories..... 13
    - (1) RS485 Communication Cable P1 or P2..... 13
    - (2) RS485 Communication Group Network Cable P1 or P2..... 14
- 5. DS-CLS9-FETC-2A (DS-CLS9-FETC-2I)..... 15
  - 5.1 Dimensional Drawing..... 15
  - 5.2 Accessories..... 15
    - (1) Power Extension Cable P1..... 15
    - (2) Motor Extension Cable P2 or P7..... 16
    - (3) Brake Extension Cable P3 or P8..... 16
    - (4) Encoder Extension Cable P4 or P9..... 17
    - (5) RJ45 Communication Cable ② to Driver P5 or P6..... 18

- 6. DS-BVS-FETC (DS-BVS-FCAO).....19
  - 6.1 Dimensional Drawing.....19
  - 6.2 Accessories.....19
    - (1) I/O extension cable P1.....19
    - (2) Encoder extension cable P2.....20
    - (3) Encoder extension cable P3.....21
    - (4) Encoder extension cable P4.....21
    - (5) RJ45 Communication Cable ② to Driver P5 or P6.....22
    - (6) Communication cable-PC P7.....23
  
- 7. DS-BVM-FETC(DS-BVM-FCAO).....24
  - 7.1 Dimensional Drawing.....24
  - 7.2 Accessories.....24
    - (1) Communication cable P1 or P2.....24
    - (2) I/O cable P3.....25
    - (3) Encoder cable P4.....25
    - (4) Communication cable P5 or P6.....26
    - (5) Encoder extension cable P7.....27
    - (6) Power extension cable P8.....27
    - (7) Motor extension cable P9.....28
    - (8) Encoder extension cable P10.....28
    - (9) Communication cable-PC P11.....29
  
- 8. DS-CLS9-FETC.....30
  - 8.1 Dimensional Drawing.....30
  - 8.2 Accessories.....30
    - (1) Power extension cable P1.....30
    - (2) Motor extension cable P2.....31
    - (3) Brake extension cable P3.....31
    - (4) Encoder extension cable P4.....32
    - (5) I/O extension cable P5.....33
    - (6) RJ45 communication cable ② to Driver P6 or P7.....34
    - (7) Communication cable-PC P8.....34
  
- 9. DS-CLS3-FETC-4I.....35
  - 9.1 Dimensional Drawing.....35
  - 9.2 Accessories.....35
    - (1) Communication cable-PC P1.....35
    - (2) RJ45 communication cable ② to Driver P2 or P3.....36

# 1. DS-CLS10-FRS4 (DS-CLS9-FCAO)

## 1.1 Dimensional Drawing

Unit : mm

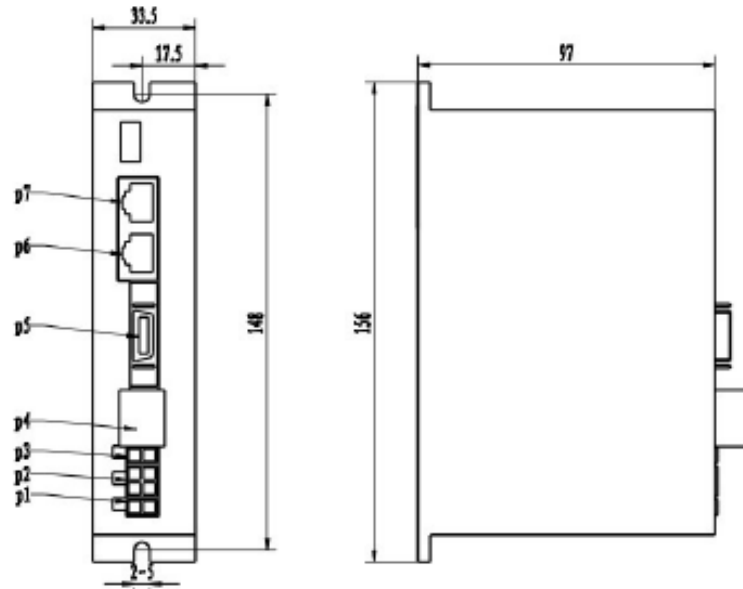

## 1.2 Accessories

### (1) Power Extension Cable P1

Ordering Model	L (mm)	Item Number	Ver. Number
PEC-1.0-14.549	1000	09-531-1	REV 03
PEC-3.0-14.549	3000	09-531-2	REV 03
PEC-5.0-14.549	5000	09-531-3	REV 03

Connector Model : 5557-2 \* 1R, 5559-2 \* 1P

Wire Harness : 0.5mm\*2, 200W secondary bending with drag chain motion cable

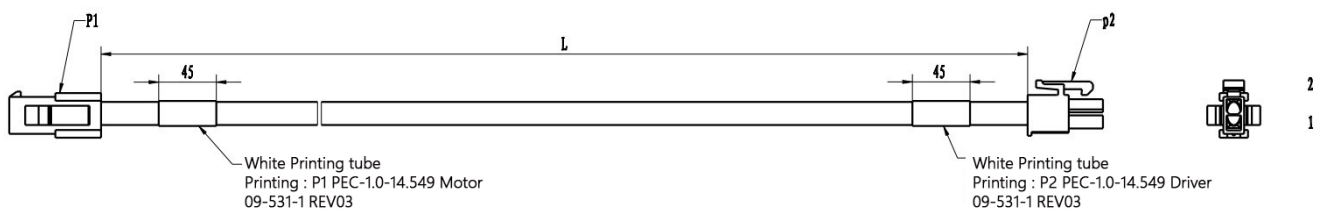

### Interface Definition

PIN	DS-CLS10-FRS4 DS-CLS9-FCAO	Color
1	GND	Black
2	V+	Red

**(2) Motor Extension Cable P2**

Ordering Model	L(mm)	Item Number	Ver. Number
MEC-1.0-14.549	1000	09-532-1	REV 03
MEC-3.0-14.549	3000	09-532-2	REV 03
MEC-5.0-14.549	5000	09-532-3	REV 03

Connector Model : 5557-2 \* 2R, 5559-2 \* 2P

Wire Harness : 0.5mm\*4, 200W secondary bending with drag chain motion cable

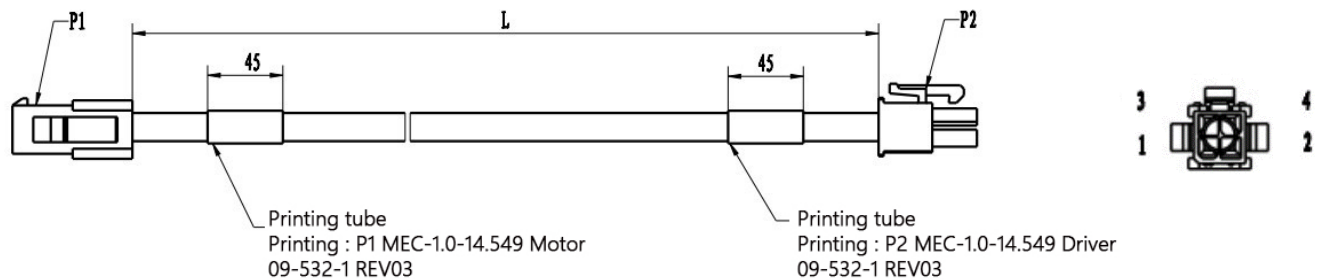

**Interface Definition**

PIN	DS-CLS10-FRS4	Color
	DS-CLS9-FCAO	
1	B -	Blue
2	A -	Green
3	B +	Red
4	A +	Yellow

**(3) Brake Extension Cable P3**

Ordering Model	L (mm)	Item Number	Ver. Number
BEC-1.0-14.549	1000	09-533-1	REV 03
BEC-3.0-14.549	3000	09-533-2	REV 03
BEC-5.0-14.549	5000	09-533-3	REV 03

Connector Model : 5557-2 \* 1R, 5559-2 \* 1P

Wire Harness : 0.5mm\*2, 200W secondary bending with drag chain motion cable

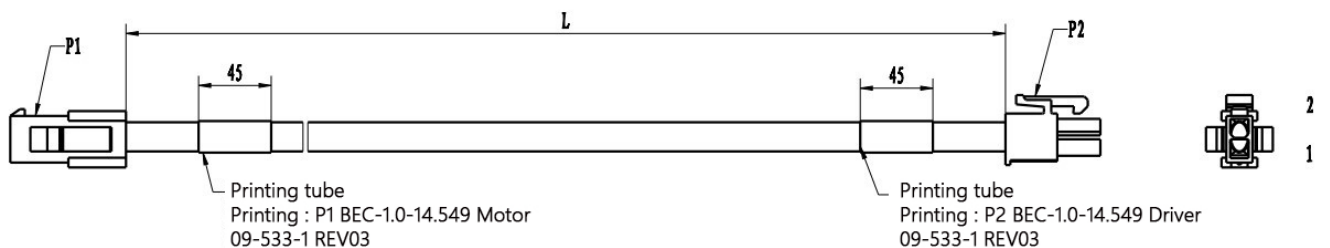

**Interface Definition**

PIN	DS-CLS10-FRS4	Color
	DS-CLS9-FCAO	
1	Brake -	Black
2	Brake +	Red

**(4) Encoder Extension Cable P4**

Ordering Model	L (mm)	Item Number	Ver. Number
EEC-1.0-14.418	1000	09-509	REV 03
EEC-3.0-14.418	3000	09-509-1	REV 03
EEC-5.0-14.418	5000	09-509-2	REV 03

Connector Model : SMP-10V-NC

Wire Harness : 5P\*26AWG, 200W secondary bending with drag chain motion cable with shield.

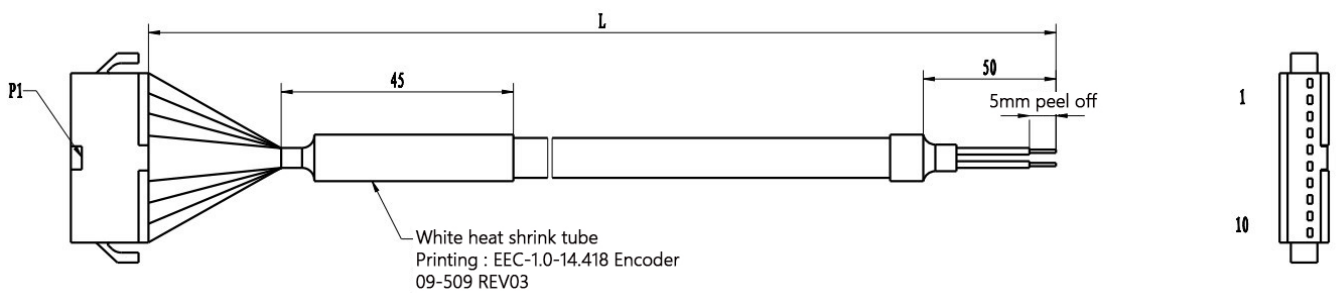

**Interface Definition**

PIN	DS-CLS10-FRS4	Color
	DS-CLS9-FCAO	
1	+5V	Red
2	GND	Black
3	A +	Yellow
4	A -	Yellow Black
5	B +	Green
6	B -	Green Black
7	Z +	Blue
8	Z -	Blue Black
9	FG	Black White
10	NC	Red White

**(5) I/O Extension Cable P5**

Ordering Model	L (mm)	Item Number	Ver. Number
IEC-1.0-14.549	1000	09-535-1	REV 00
IEC-3.0-14.549	3000	09-535-2	REV 00
IEC-5.0-14.549	5000	09-535-3	REV 00

Connector Model : SCSI-20P

Wire Harness : Inner core 10P\*26AWG,  
with shielding layer, supporting 200W bending times, with drag chain

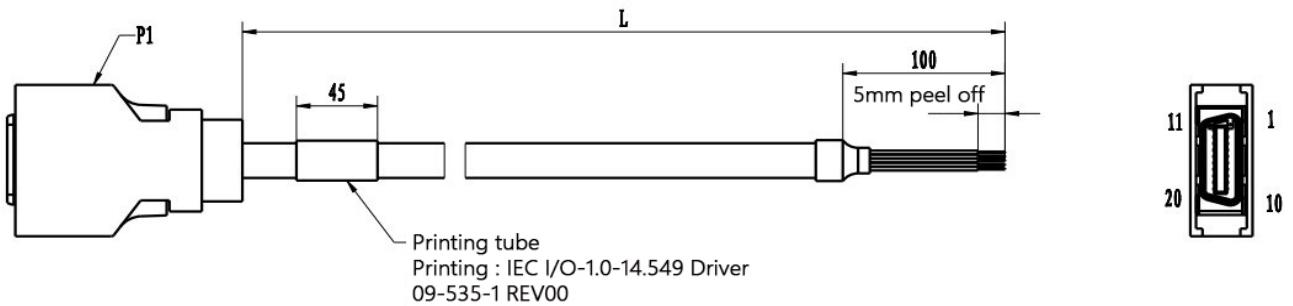

**Interface Definition**

PIN	DS-CLS10-FRS4 DS-CLS9-FCAO	Color
1	COM ( IN )	Red
2	IN1	Orange
3	IN2	Purple
4	IN3	Gray
5	IN4	Black White
6	IN5	Gray Black
7	IN6+	Blue
8	IN6-	Blue Black
9	IN7+	Green
10	IN7-	Green Black
11	OUT1	Red White
12	OUT2	Orange Black
13	OUT3	Purple Black
14	COM (OUT)	Black
15	Encoder A+	White
16	Encoder A-	White Black
17	Encoder B+	Yellow
18	Encoder B-	Yellow Black
19	Encoder Z+	Brown
20	Encoder Z-	Brown Black

**(6) RJ45 Communication Cable ② to Driver P6 or P7**

Ordering Model	L (mm)	Item Number	Ver. Number
REC-0.15-14.418	150	09-512	REV 02
REC-0.3-14.418	300	09-512-1	REV 02
REC-1.0-14.549	1000	09-534-1	REV 01
REC-3.0-14.549	3000	09-534-2	REV 01
REC-5.0-14.549	5000	09-534-3	REV 01

Connector Model : RJ45

Wire Harness : TRVVSP Crimp Resistance 4P\*26AWG

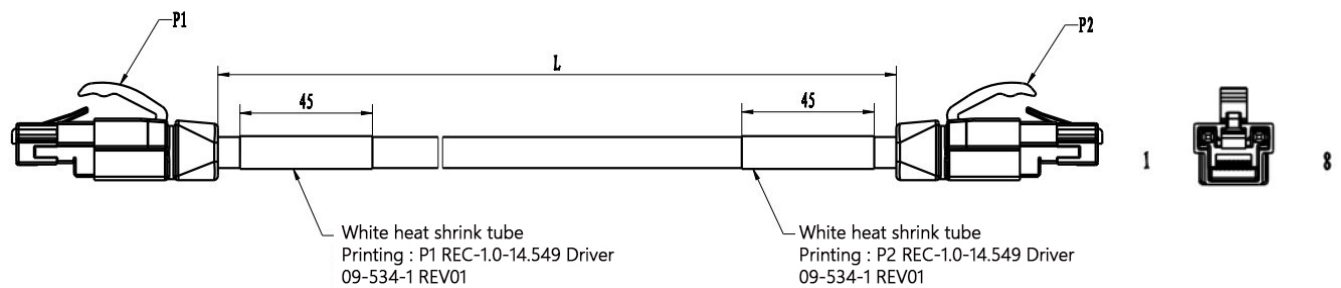

**Interface Definition**

PIN	DS-CLS10-FRS4	DS-CLS9-FCAO	Color
1	NC	CANH	White Green
2	GND	CANL	Green
3	A Input (RS485)	NC	White Orange
4	NC	GND	Blue
5	NC	GND	White Blue
6	B Input (RS485)	NC	Orange
7	Terminal resistance (CN5)	CN5	White Brown
8	Terminal resistance (CN5)	CN5	Brown



## 2. DS-CLS9-FRS4-01 (DS-CLS9-FRS4)

### 2.1 Dimensional Drawing

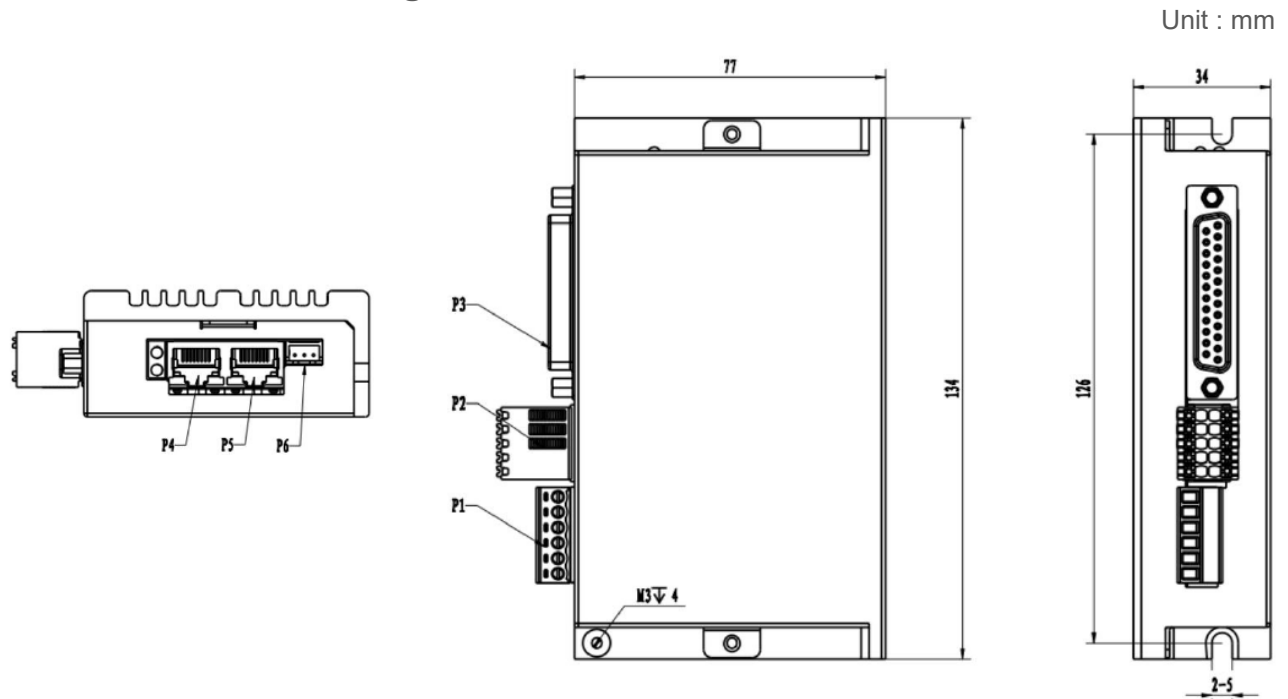

### 2.2 Accessories

#### (1) Motor Extension Cable P1

Ordering Model	L (mm)	Item Number	Ver. Number
MEC-1.0-14.418	1000	09-508	REV 04
MEC-3.0-14.418	3000	09-508-1	REV 04
MEC-5.0-14.418	5000	09-508-2	REV 04

Connector Model : 5557-2 \* 2

Wire Harness : 0.5mm\*4, 200W secondary bending with drag chain motion cable

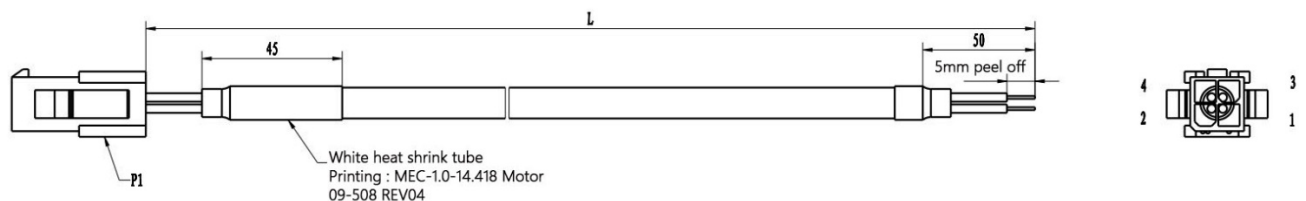

#### Interface Definition

PIN	DS-CLS9-FRS4-01 / DS-CLS9-FRS4	Color
1	B -	Blue
2	A -	Green
3	B +	Red
4	A +	Yellow

**(2) Encoder Extension Cable P2**

Ordering Model	L (mm)	Item Number	Ver. Number
EEC-1.0-14.418	1000	09-509	REV 03
EEC-3.0-14.418	3000	09-509-1	REV 03
EEC-5.0-14.418	5000	09-509-2	REV 03

Connector Model : SMP-10V-NC

Wire Harness : 5P\*26AWG, 200W secondary bending with drag chain motion cable with shield.

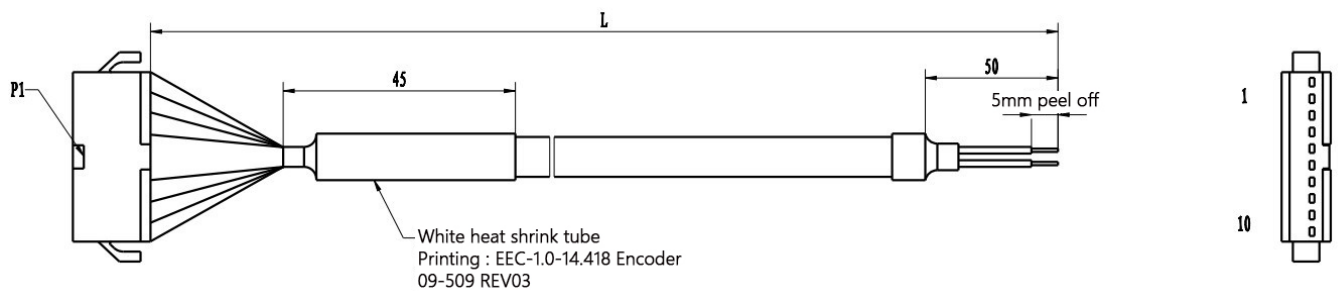

**Interface Definition**

PIN	DS-CLS9-FRS4-01 / DS-CLS9-FRS4	Color
1	+5V	Red
2	GND	Black
3	A +	Yellow
4	A -	Yellow Black
5	B +	Green
6	B -	Green Black
7	Z +	Blue
8	Z -	Blue Black
9	FG	Black White
10	NC	Red White

**(3) I/O Extension Cable P3**

Ordering Model	L (mm)	Item Number	Ver. Number
IEC-1.0-14.418	1000	09-510	REV 02
IEC-3.0-14.418	3000	09-510-1	REV 02
IEC-5.0-14.418	5000	09-510-2	REV 02

Connector Model : DB25

Terminal Model : Solid gold pin

Wire Harness : 28AWG \* 25 core double shielded wire

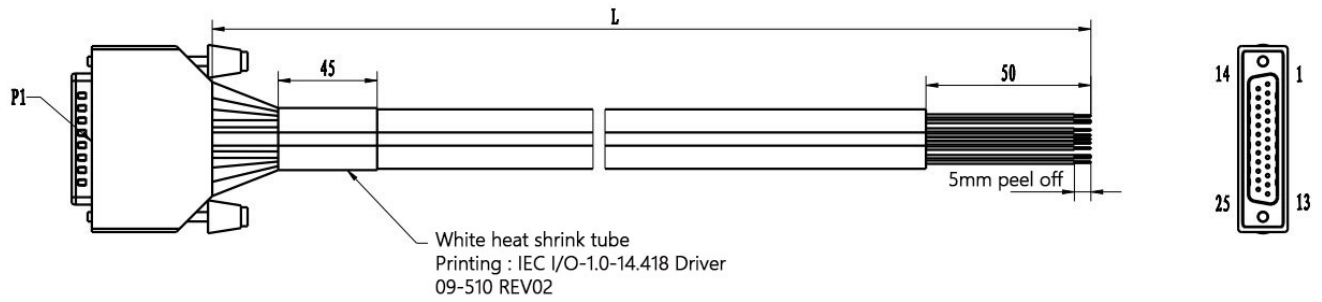

**Interface Definition**

PIN	DS-CLS9-FRS4-01 / DS-CLS9-FRS4	Color
1	+COM ( 24V )	Red
2	NC	Pink
3	NC	Light Green
4	NC	Purple White
5	IN1	Red Black
6	IN2	Orange Black
7	IN3	Yellow Black
8	IN4	Green Black
9	IN5	Gray Black
10	OUT1	Brown
11	OUT2	Orange
12	OUT3	Yellow
13	OUT4	Green
14	CW+	Blue
15	CW-	Purple
16	CCW+	Gray
17	CCW-	White
18	Encoder A+	Red White
19	Encoder A-	Orange White
20	Encoder B+	Green White
21	Encoder B-	Blue White
22	Encoder Z+	Black White
23	Encoder Z-	Brown White
24	FG	Pink Black
25	-COM (0V)	Black

**(4) RJ45 Communication Cable ① to RJ45 P4 or P5**

Ordering Model	L (mm)	Item Number	Ver. Number
REC-1.0-14.418	1000	09-511	REV 02

Connector Model : RJ45

Wire Harness : TRVVSP Crimp Resistance 26AWG\*4P

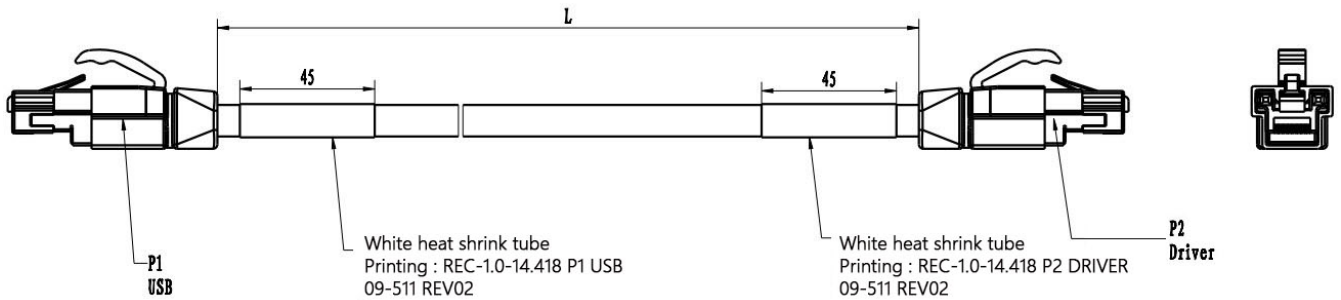

**Interface Definition**

P1	DS-CLS9-FRS4-01 / DS-CLS9-FRS4	Color
1	A	White Orange
2	B	Orange
3	NC	White Green
4	NC	Blue
5	NC	White Blue
6	NC	White Brown
7	GND	Green
8	GND	Brown

P2	DS-CLS9-FRS4-01 / DS-CLS9-FRS4	Color
1	NC	White Green
2	GND	Green
3	A	White Orange
4	NC	Blue
5	NC	White Blue
6	B	Orange
7	NC	White Brown
8	NC	Brown

**(5) RJ45 Communication Cable ② to Driver P4 or P5**

Ordering Model	L (mm)	Item Number	Ver. Number
REC-0.15-14.418	150	09-512	REV 02
REC-0.3-14.418	300	09-512-1	REV 02
REC-1.0-14.549	1000	09-534-1	REV 01
REC-3.0-14.549	3000	09-534-2	REV 01
REC-5.0-14.549	5000	09-534-3	REV 01

Connector Model : RJ45

Wire Harness : TRVVSP Crimp Resistance 26AWG \*4P

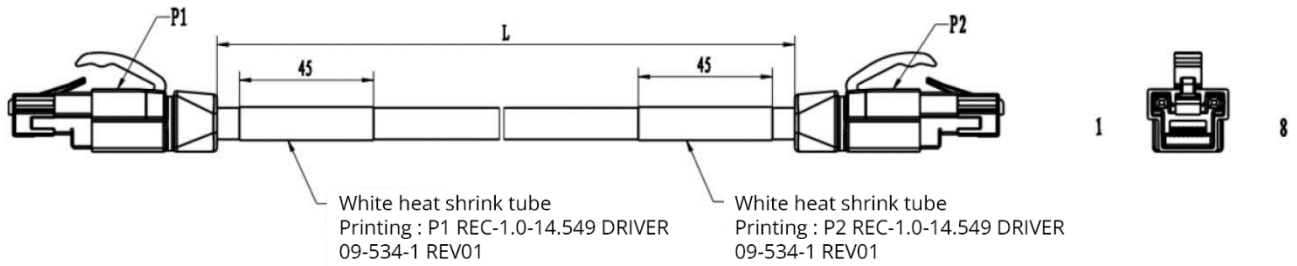

**Interface Definition**

P1	DS-CLS9-FRS4-01 / DS-CLS9-FRS4	Color
1	NC	White Green
2	GND	Green
3	A	White Orange
4	NC	Blue
5	NC	White Blue
6	B	Orange
7	NC	White Brown
8	NC	Brown

**(6) USB to RJ45 Converter to PC**

Ordering Model	L (mm)	Item Number	Ver. Number
RS485 Converter	190.5	14-707	REV 00

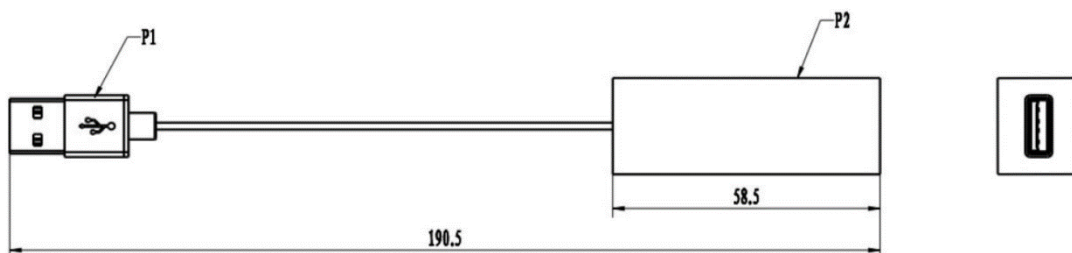

### 3. DS-OLS8-FRS4

#### 3.1 Dimensional Drawing

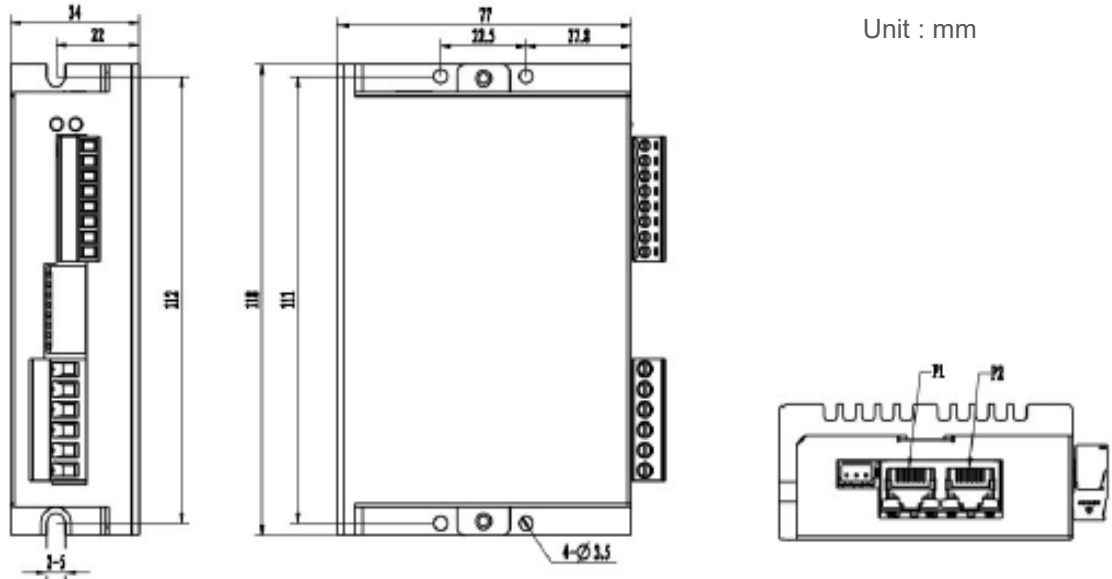

#### 3.2 Accessories

##### (1) RJ45 Communication Cable ① to RJ45 P1 or P2

Ordering Model	L (mm)	Item Number	Ver. Number
REC-1.0-14.418	1000	09-511	REV 02

Connector Model : RJ45

Wire Harness : TRVVSP Crimp Resistance 26AWG\*4P

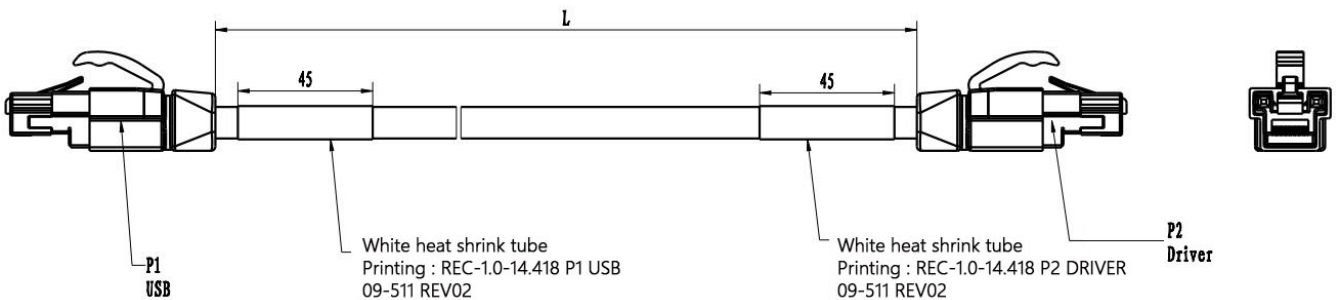

#### Interface Definition

P1	DS-OLS8-FRS4	Color
1	A	White Orange
2	B	Orange
3	NC	White Green
4	NC	Blue
5	NC	White Blue
6	NC	White Brown
7	GND	Green
8	GND	Brown

P2	DS-OLS8-FRS4	Color
1	NC	White Green
2	GND	Green
3	A	White Orange
4	NC	Blue
5	NC	White Blue
6	B	Orange
7	NC	White Brown
8	NC	Brown

**(2) RJ45 Communication Cable ② to Driver P1 or P2**

Ordering Model	L (mm)	Item Number	Ver. Number
REC-0.15-14.418	150	09-512	REV 02
REC-0.3-14.418	300	09-512-1	REV 02

Connector Model : RJ45

Wire Harness : TRVVSP Crimp Resistance 26AWG \*4P

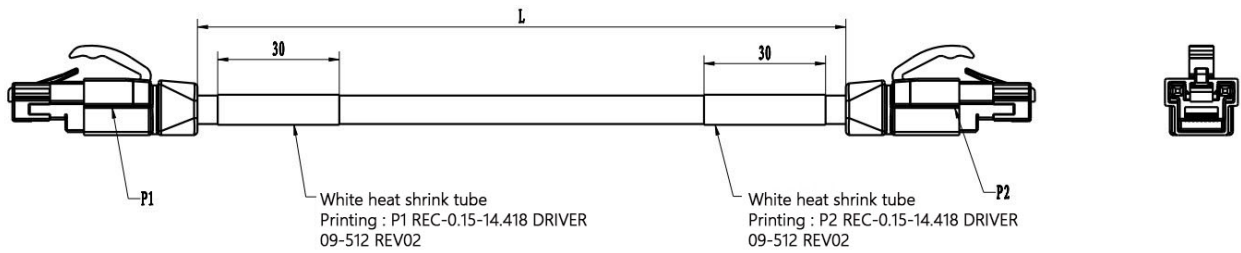

**Interface Definition**

P1 P2	DS-OLS8-FRS4	Color
1	NC	White Green
2	GND	Green
3	A	White Orange
4	NC	Blue
5	NC	White Blue
6	B	Orange
7	NC	White Brown
8	NC	Brown

**(3) USB to RJ45 Converter to PC**

Ordering Model	L (mm)	Item Number	Ver. Number
RS485 Converter	-	14-707	REV 00

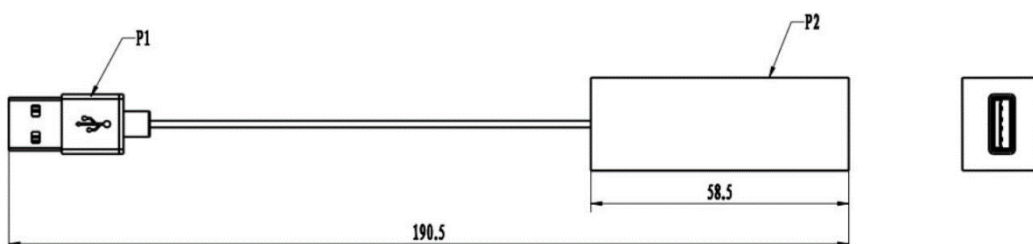

## 4. DS-OLS7-FRS4

### 4.1 Dimensional Drawing

Unit : mm

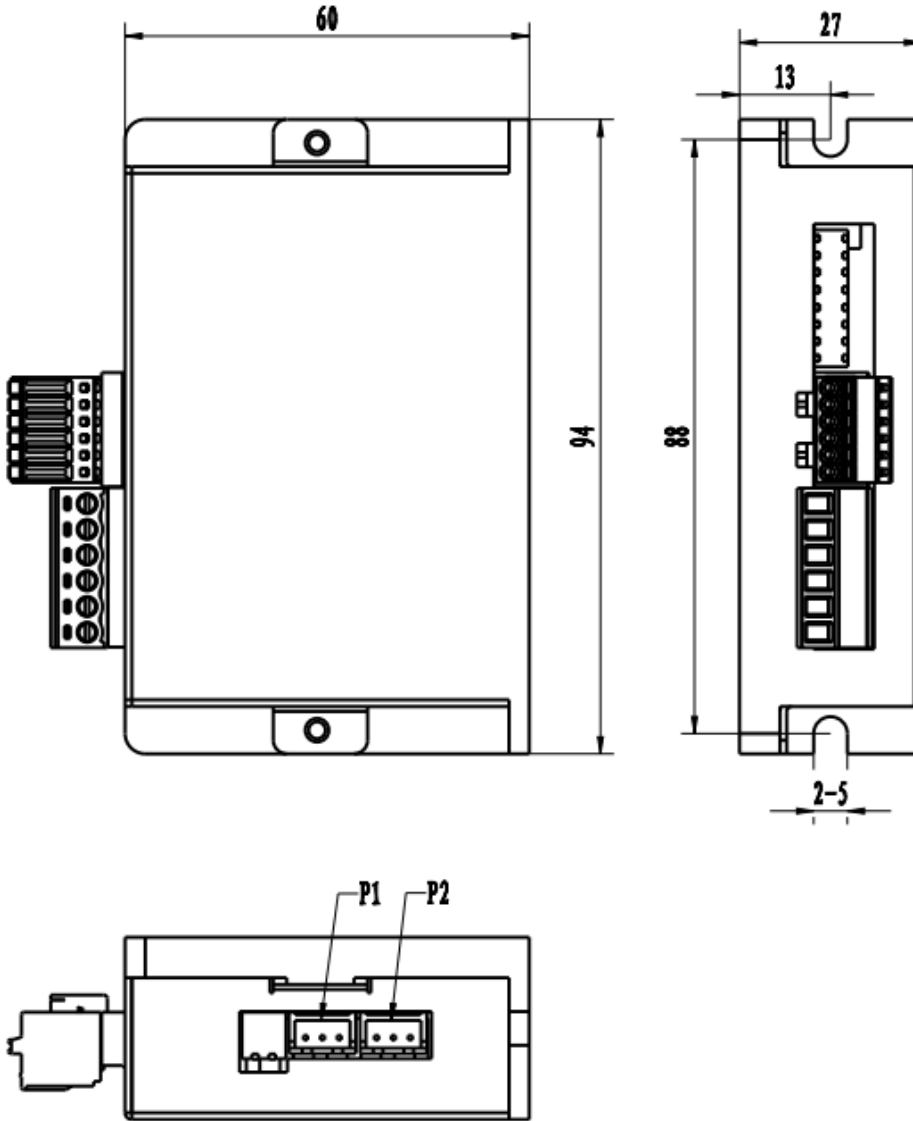

### 4.2 Accessories

#### (1) RS485 Communication Cable P1 or P2

Ordering Model	L (mm)	Item Number	Ver. Number
REC-1.0-14.414	1000	09-516	REV 01

Connector Model : XHP-3

Terminal Model: SXH-001T-P0.6

Supplier : JST

Wire Harness : UL 2464 28AWG\*3C



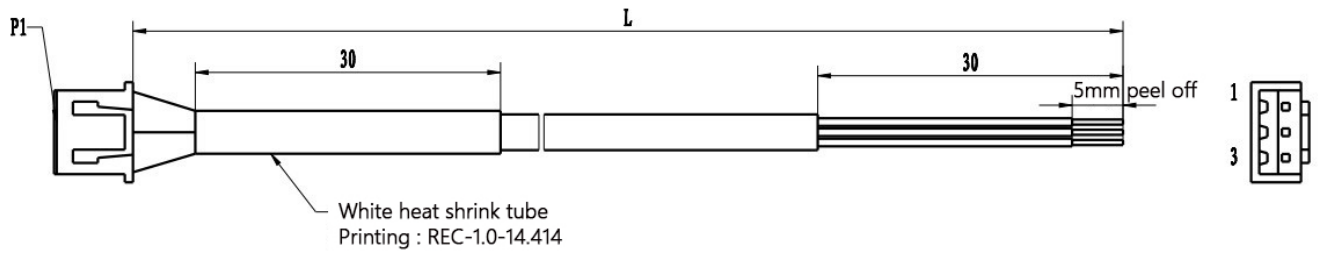

**Interface Definition**

PIN	DS-OLS7-FRS4	Color
1	RS485 GND	Red
2	B	Yellow
3	A	Black

**(2) RS485 Communication Group Network Cable P1 or P2**

Ordering Model	L (mm)	Item Number	Ver. Number
REC-0.15D-14.414	150	09-517	REV 02
REC-1.0D-14.414 connector	1000	09-517-1	REV 00

Connector Model : XHP-3

Terminal Model: SXH-001T-P0.6

Supplier : JST

Wire Harness : UL 2464 28AWG\*3C

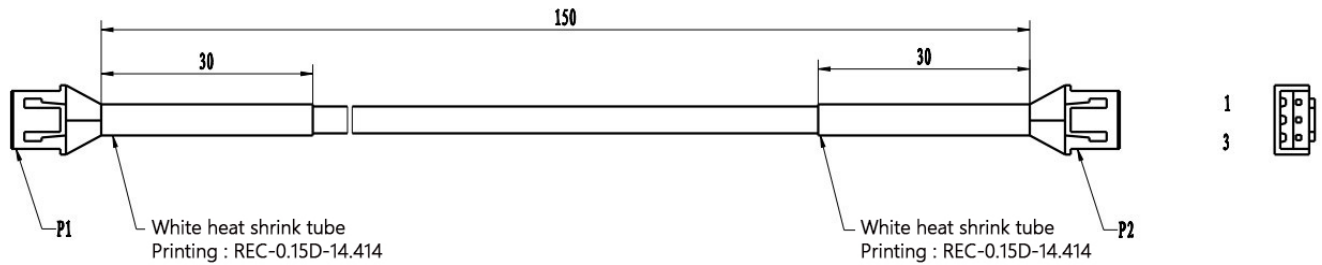

**Interface Definition**

P1 P2	DS-OLS7-FRS4	Color
1	RS485 GND	Red
2	B	Yellow
3	A	Black

## 5. DS-CLS9-FETC-2A (DS-CLS9-FETC-2I)

### 5.1 Dimensional Drawing

Unit : mm

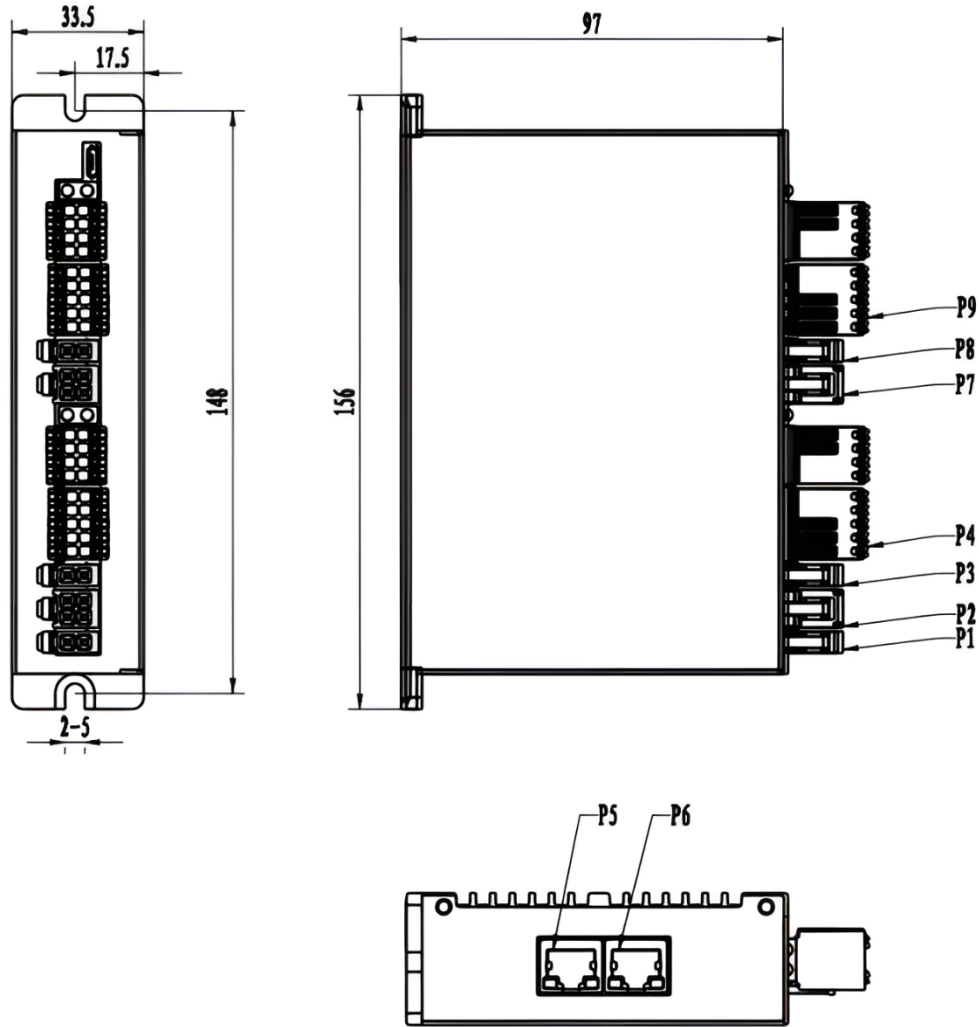

### 5.2 Accessories

#### (1) Power Extension Cable P1

Ordering Model	L (mm)	Item Number	Ver. Number
PEC-1.0-14.549	1000	09-531-1	REV 03
PEC-3.0-14.549	3000	09-531-2	REV 03
PEC-5.0-14.549	5000	09-531-3	REV 03

Connector Model : 5557-2 \* 1R, 5559-2 \* 1P

Wire Harness : 0.5mm\*2, 200W secondary bending with drag chain motion cable

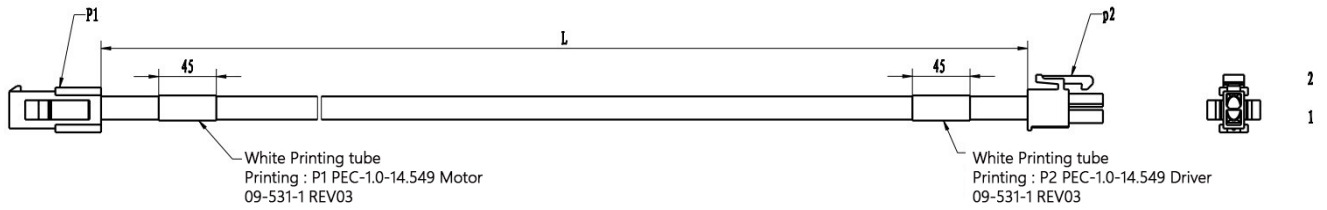

**Interface Definition**

PIN	DS-CLS9-FETC-2A / DS-CLS9-FETC-2I	Color
1	GND	Black
2	V+	Red

**(2) Motor Extension Cable P2 or P7**

Ordering Model	L(mm)	Item Number	Ver. Number
MEC-1.0-14.549	1000	09-532-1	REV 03
MEC-3.0-14.549	3000	09-532-2	REV 03
MEC-5.0-14.549	5000	09-532-3	REV 03

Connector Model : 5557-2 \* 2R, 5559-2 \* 2P

Wire Harness : 0.5mm\*4, 200W secondary bending with drag chain motion cable

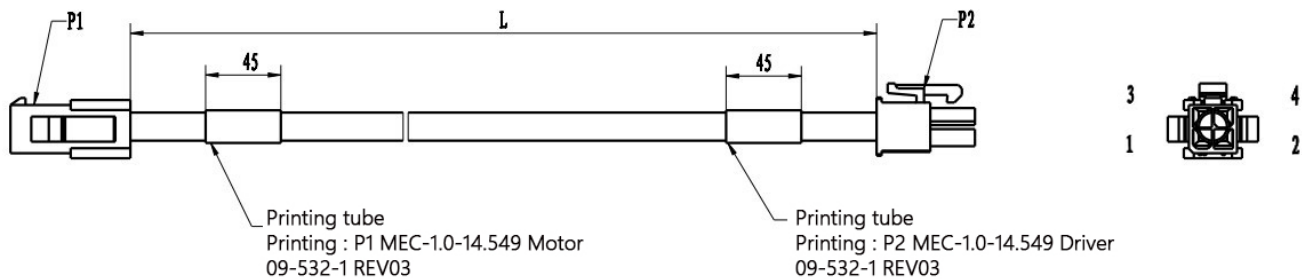

**Interface Definition**

PIN	DS-CLS9-FETC-2A / DS-CLS9-FETC-2I	Color
1	B -	Blue
2	A -	Green
3	B +	Red
4	A +	Yellow

**(3) Brake Extension Cable P3 or P8**

Ordering Model	L (mm)	Item Number	Ver. Number
BEC-1.0-14.549	1000	09-533-1	REV 03
BEC-3.0-14.549	3000	09-533-2	REV 03
BEC-5.0-14.549	5000	09-533-3	REV 03

Connector Model : 5557-2 \* 1R, 5559-2 \* 1P

Wire Harness : 0.5mm\*2, 200W secondary bending with drag chain motion cable

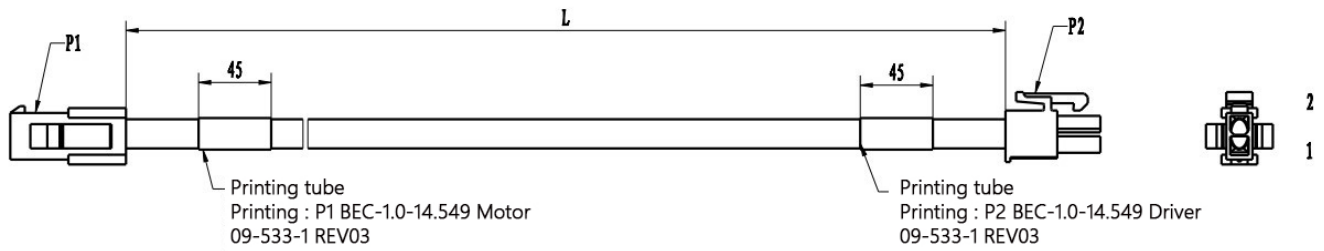

**Interface Definition**

PIN	DS-CLS9-FETC-2A / DS-CLS9-FETC-2I	Color
1	Brake -	Black
2	Brake +	Red

**(4) Encoder Extension Cable P4 or P9**

Ordering Model	L (mm)	Item Number	Ver. Number
EEC-1.0-14.418	1000	09-509	REV 03
EEC-3.0-14.418	3000	09-509-1	REV 03
EEC-5.0-14.418	5000	09-509-2	REV 03

Connector Model : SMP-10V-NC

Wire Harness : 5P\*26AWG, 200W secondary bending with drag chain motion cable with shield.

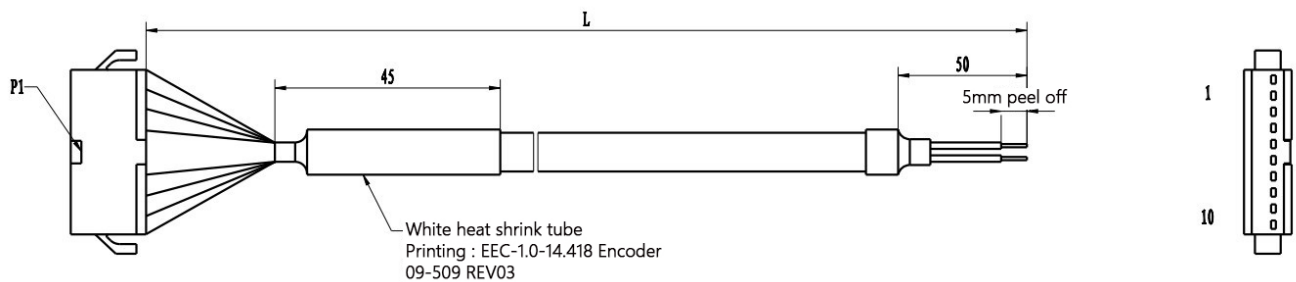

**Interface Definition**

PIN	DS-CLS9-FETC-2A / DS-CLS9-FETC-2I	Color
1	+5V	Red
2	GND	Black
3	A +	Yellow
4	A -	Yellow Black
5	B +	Green
6	B -	Green Black
7	Z +	Blue
8	Z -	Blue Black
9	FG	Black White
10	NC	Red White

**(5) RJ45 Communication Cable ② to Driver P5 or P6**

Ordering Model	L (mm)	Item Number	Ver. Number
REC-0.15-14.418	150	09-512	REV 02
REC-0.3-14.418	300	09-512-1	REV 02
REC-1.0-14.549	1000	09-534-1	REV 01
REC-3.0-14.549	3000	09-534-2	REV 01
REC-5.0-14.549	5000	09-534-3	REV 01

Connector Model : RJ45

Wire Harness : TRVVSP Crimp Resistance 26AWG \*4P

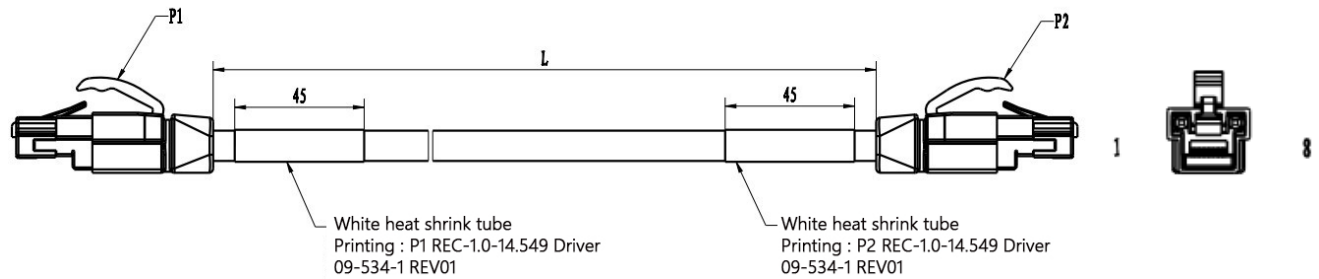

**Interface Definition**

P1 P2	DS-CLS9-FETC-2A / DS-CLS9-FETC-2I	Color
1	E_TX+	White Green
2	E_TX-	Green
3	E_RX+	White Orange
4		Blue
5		White Blue
6	E_RX-	Orange
7		White Brown
8		Brown

## 6. DS-BVS-FETC(DS-BVS-FCAO)

### 6.1 Dimensional Drawing

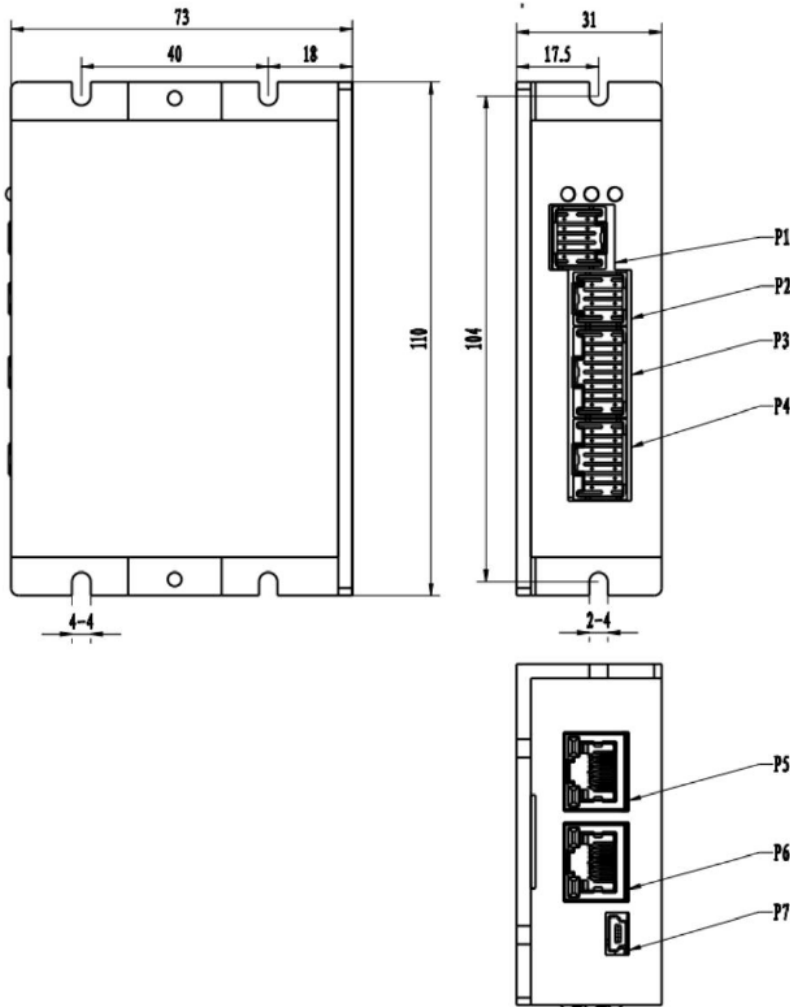

### 6.2 Accessories

#### (1) I/O extension cable P1 order

Ordering Model	L (mm)	Item Number	Ver. Number
IEC-0.5-14-563	500	09-551	REV 00

Connector Model : Molex-51353-1000

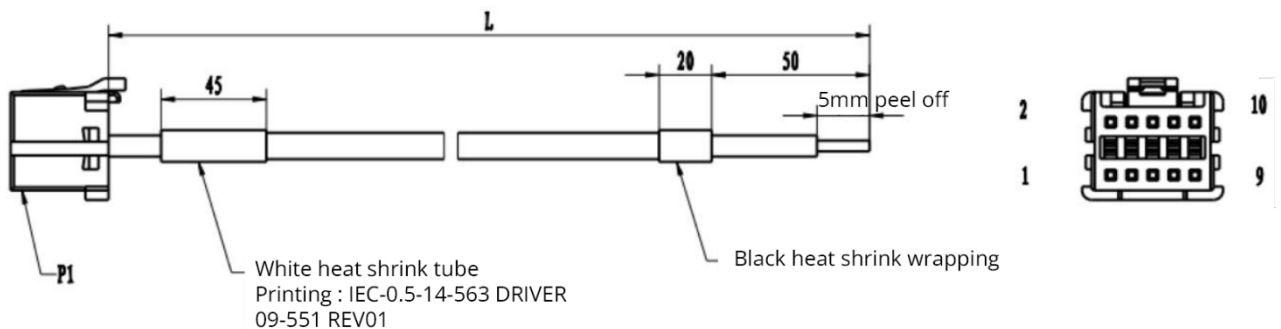

**Interface Definition**

PIN	DS-BVS-FETC / DS-BVS-FCAO	Color
1	STO	pink
2	NEGATIVE_LIMIT	pink gray
3	POSITIVE_LIMIT	blue
4	HOME	blue gray
5	GPI 0	green
6	GPI 1	green gray
7	GPI_COMMON	purple
8	GPO 0	purple gray
9	GPO 1	orange
10	GPO_COMMON	orange gray

**(2) Encoder extension cable P2**

Ordering Model	L(mm)	Item Number	Ver. Number
BEEC-0.5-14-563	500	09-549	REV 01

Connector Model : Molex- 51353-0800

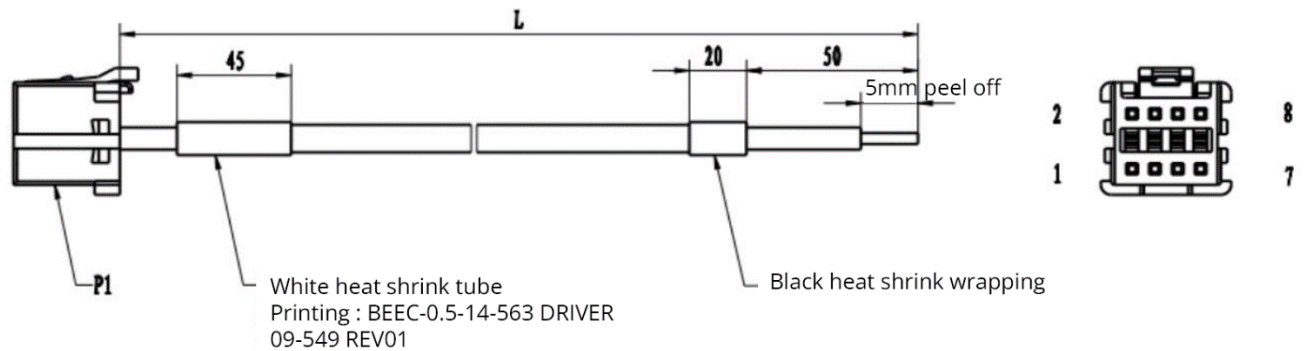

**Interface Definition**

PIN	DS-BVS-FETC / DS-BVS-FCAO	Color
1	BISS_DATA+ (SLO+)	red
2	BISS_DATA- (SLO-)	red gray
3	BISS_CLK+ (MA+)	yellow
4	BISS_CLK- (MA-)	yellow gray
5	RS485_RTX+	white
6	RS485_RTX-	white gray
7	5V	blue
8	GND	blue gray

### (3) Encoder extension cable P3

Ordering Model	L (mm)	Item Number	Ver. Number
DEEC-0.5-14-563	500	09-550	REV 01

Connector Model : Molex-51353-1600

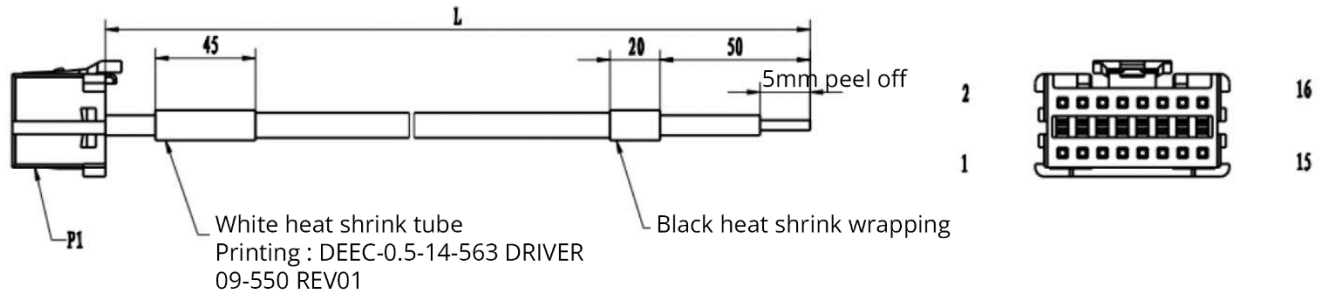

### Interface Definition

PIN	DS-BVS-FETC / DS-BVS-FCAO	Color
1	5V	red
2	GND	red gray
3	Encoder A+	white
4	Encoder A-	white gray
5	Encoder B+	yellow
6	Encoder B-	yellow gray
7	Encoder I+	pink
8	Encoder I-	pink gray
9	HALL U+	blue
10	HALL U-	blue gray
11	HALL V+	green
12	HALL V-	green gray
13	HALL W+	purple
14	HALL W-	purple gray
15	FG	orange
16	GND	orange gray

### (4) Encoder extension cable P4

Ordering Model	L (mm)	Item Number	Ver. Number
AEEC-0.5-14-563	500	09-548	REV 01

Connector Model : Molex-51353-1400



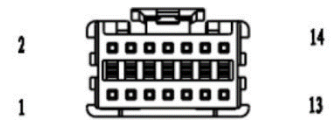
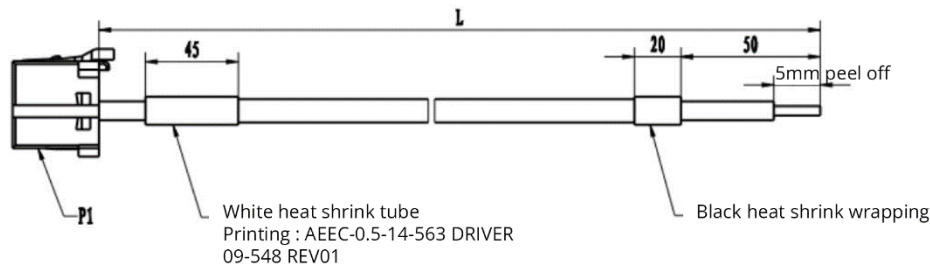

**Interface Definition**

PIN	DS-BVS-FETC / DS-BVS-FCAO	Color
1	SIN+	pink
2	SIN-	pink gray
3	COS+	white
4	COS-	white gray
5	REF+	yellow
6	REF-	yellow gray
7	5V	red
8	GND	red gray
9	FG	blue
10	AHALL_U	blue gray
11	AHALL_V	green
12	AHALL_W	green gray
13	AIN+	purple
14	AIN-	purple gray

**(5) RJ45 communication cable ② to Driver P5 or P6**

Ordering Model	L (mm)	Item Number	Ver. Number
REC-0.15-14.418	150	09-512	REV 02
REC-0.3-14.418	300	09-512-1	REV 02
REC-1.0-14.549	1000	09-534-1	REV 01
REC-3.0-14.549	3000	09-534-2	REV 01
REC-5.0-14.549	5000	09-534-3	REV 01

Connector Model : RJ45

Wire Harness: TRVVSP Curl Resistant 4p\* 26AWG

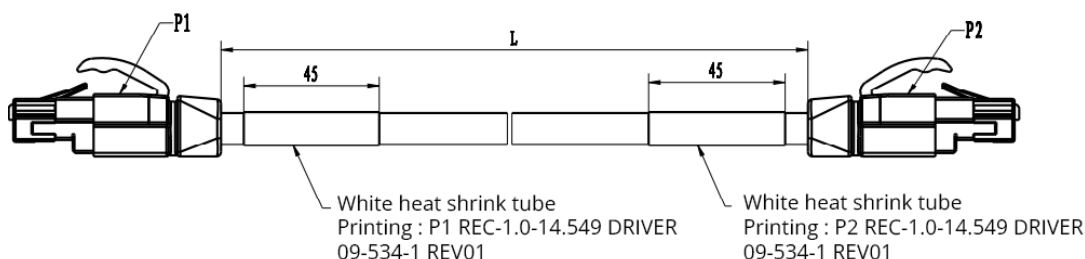

**Interface Definition**

P1 P2	EtherCAT	CAN	Color
1	EtherCAT Tx+	HIGH	white green
2	EtherCAT Tx-	LOW	green
3	EtherCAT Rx+	GND	white orange
4	NC	NC	blue
5	NCs	NC	white blue
6	EtherCAT Rx-	NC	orange
7	NC	GND	white brown
8	NC	NC	brown

**(6) Communication cable-PC P7**

Ordering Model	L (mm)	Item Number	Ver. Number
USB MINI	800	09-555	REV 00

Connector Model : USB-Mini Type B

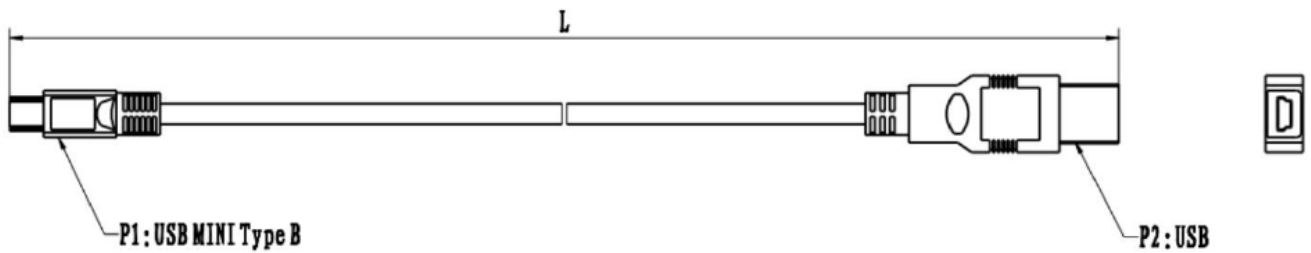

**Interface Definition**

PIN	DS-BVS-FETC / DS-BVS-FCAO
1	VBUS
2	DM
3	DP
4	ID
5	GND
6	SHIELD

## 7. DS-BVM-FETC (DS-BVM-FCAO)

### 7.1 Dimensional Drawing

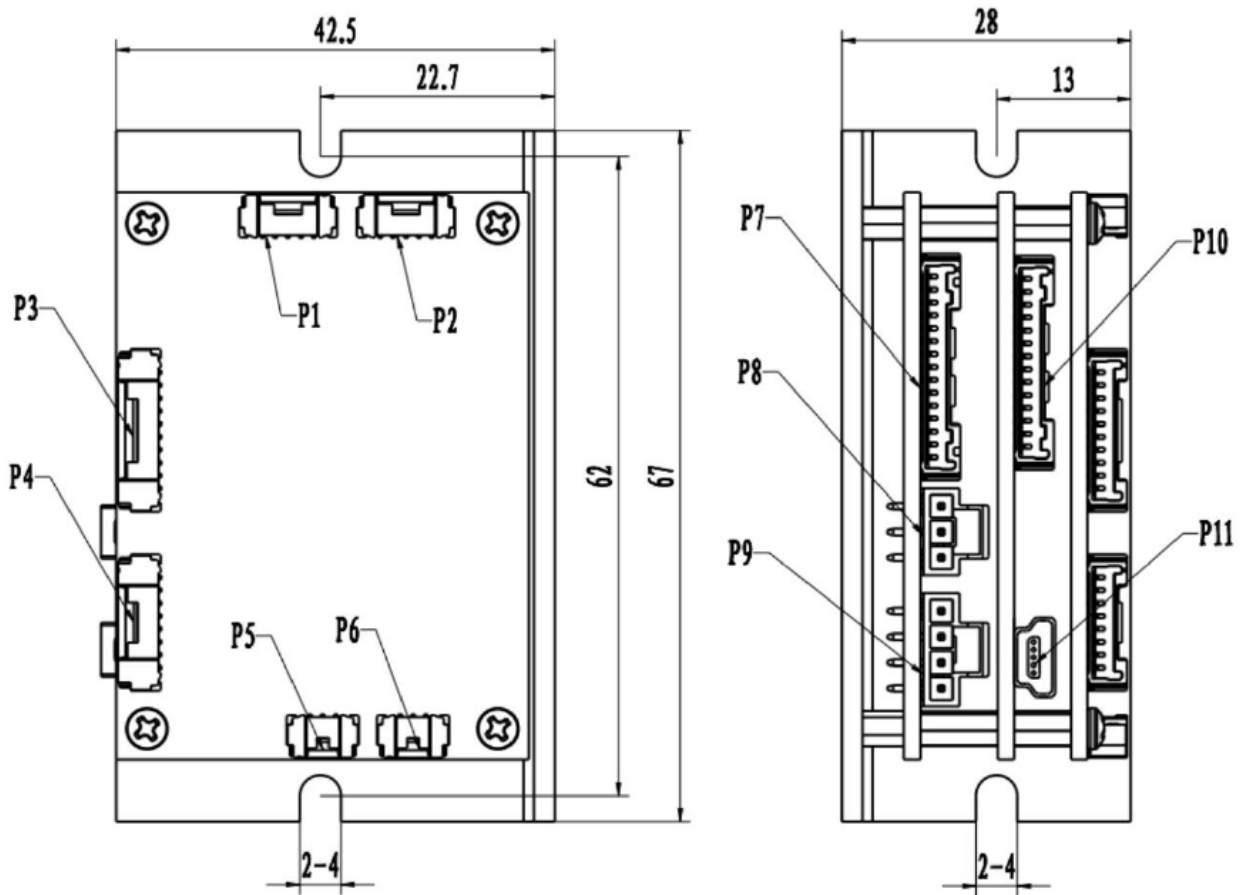

### 7.2 Accessories

#### (1) Communication cable P1 or P2

Ordering Model	L (mm)	Item Number	Ver. Number
EREC-0.5-14-559	500	09-546	REV 01

Connector Model : Molex-505565-0501

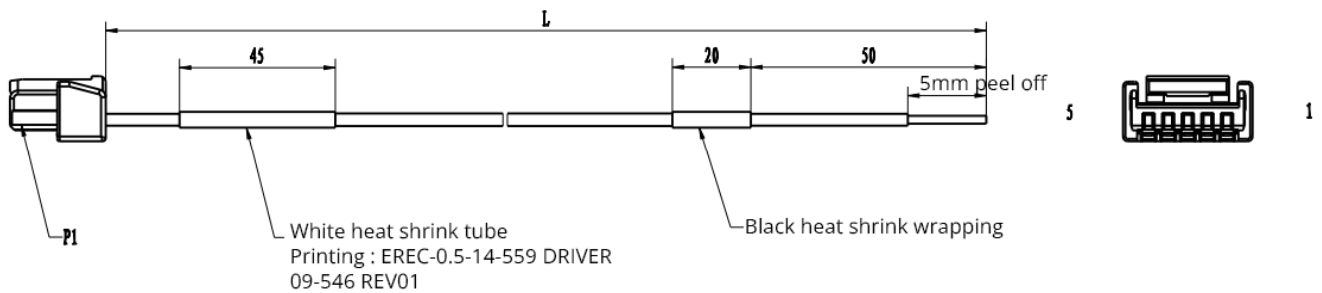

**Interface Definition**

PIN	DS-BVM-FETC / DS-BVM-FCAO	Color
1	EtherCAT Tx+	red
2	EtherCAT Tx-	red gray
3	EtherCAT Rx+	blue
4	EtherCAT Rx-	blue gray
5	NCs	yellow

**(2) I/O cable P3**

Ordering Model	L (mm)	Item Number	Ver. Number
IEC-0.5-14-559	500	09-545	REV 01

Connector Model : Molex-505565-1001

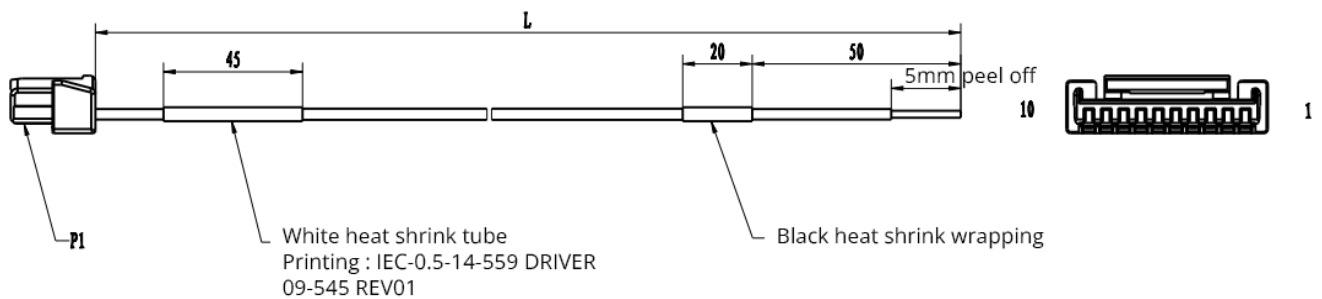

**Interface Definition**

PIN	DS-BVM-FETC / DS-BVM-FCAO	Color
1	STO	pink
2	NEGATIVE_LIMIT	pink gray
3	POSITIVE_LIMIT	white
4	HOME	white gray
5	GPI 0	yellow
6	GPI 1	yellow gray
7	GPI_COMMON	red
8	GPO 0	red gray
9	GPO 1	blue
10	GPO_COMMON	blue gray

**(3) Encoder cable P4**

Ordering Model	L (mm)	Item Number	Ver. Number
SEEC-0.5-14-559	500	09-544	REV 01

Connector Model : Molex-505565-0801

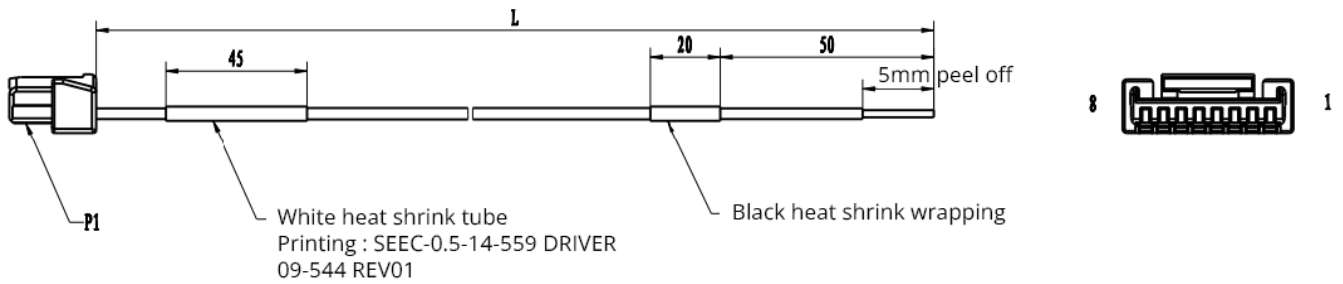

**Interface Definition**

PIN	DS-BVM-FETC / DS-BVM-FCAO	Color
1	BISS_DATA+	pink
2	BISS_DATA-	pink gray
3	BISS_CLK+	white
4	BISS_CLK-	white gray
5	5V	red
6	GND	red gray
7	RS485_RTX+	yellow
8	RS485_RTX-	yellow gray

**(4) Communication cable P5 or P6**

Ordering Model	L (mm)	Item Number	Ver. Number
CREC-0.5-14-559	500	09-547	REV 01

Connector Model : Molex-505565-0301

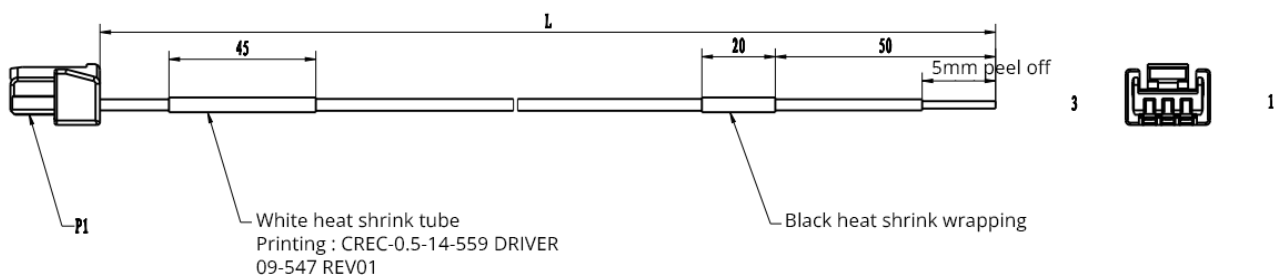

**Interface Definition**

PIN	DS-BVM-FETC / DS-BVM-FCAO	Color
1	HIGH	red
2	LOW	red gray
3	GND	blue

**(5) Encoder extension cable P7**

Ordering Model	L (mm)	Item Number	Ver. Number
DEEC-0.5-14-559	500	09-542	REV 01

Connector Model : Molex-505565-1501

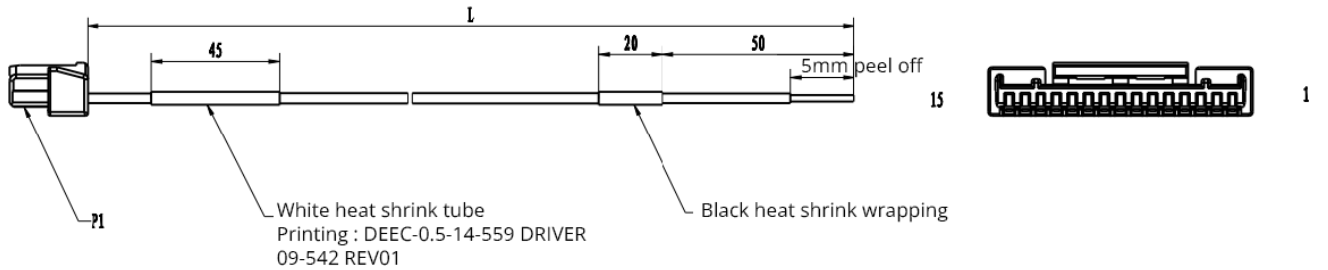

**Interface Definition**

PIN	DS-BVM-FETC / DS-BVM-FCAO	Color
1	5V	red
2	GND	red gray
3	Encoder A+	white
4	Encoder A-	white gray
5	Encoder B+	yellow
6	Encoder B-	yellow gray
7	Encoder I+	pink
8	Encoder I-	pink gray
9	HALL U+	blue
10	HALL U-	blue gray
11	HALL V+	green
12	HALL V-	green gray
13	HALL W+	purple
14	HALL W-	purple gray
15	FG	orange

**(6) Power extension cable P8**

Ordering Model	L (mm)	Item Number	Ver. Number
PEC-0.5-14-559	500	09-540	REV 00

Connector Model : Molex-105307-1203

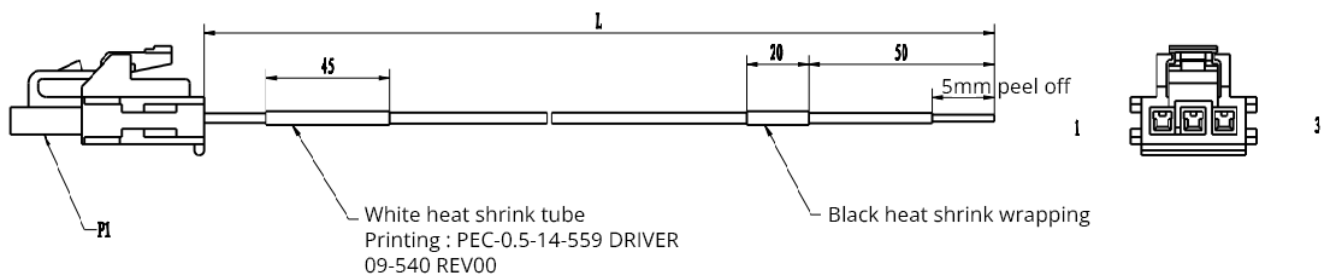

**Interface Definition**

PIN	DS-BVM-FETC / DS-BVM-FCAO	Color
1	VCC	blue
2	GND	green
3	FG	red

**(7) Motor extension cable P9**

Ordering Model	L (mm)	Item Number	Ver. Number
MEC-0.5-14-559	500	09-541	REV 00

Connector Model : Molex-105307-1204

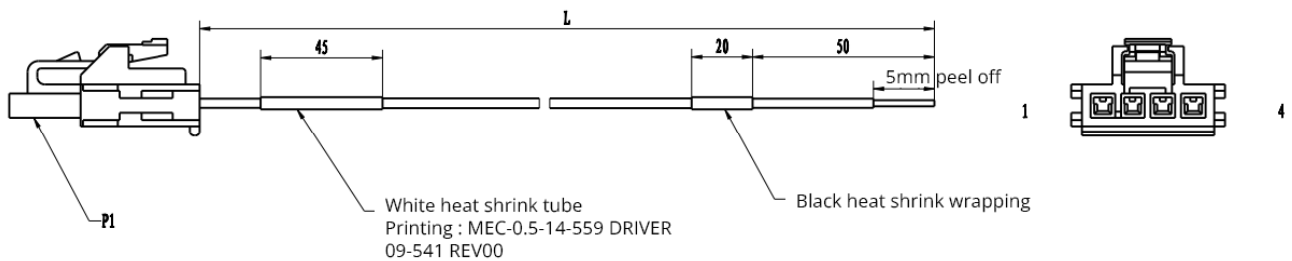

**Interface Definition**

PIN	DS-BVM-FETC / DS-BVM-FCAO	Color
1	U	blue
2	V	red
3	W	green
4	FG	yellow

**(8) Encoder extension cable P10**

Ordering Model	L (mm)	Item Number	Ver. Number
AEEC-0.5-14-559	500	09-543	REV 01

Connector Model : Molex-505565-1401

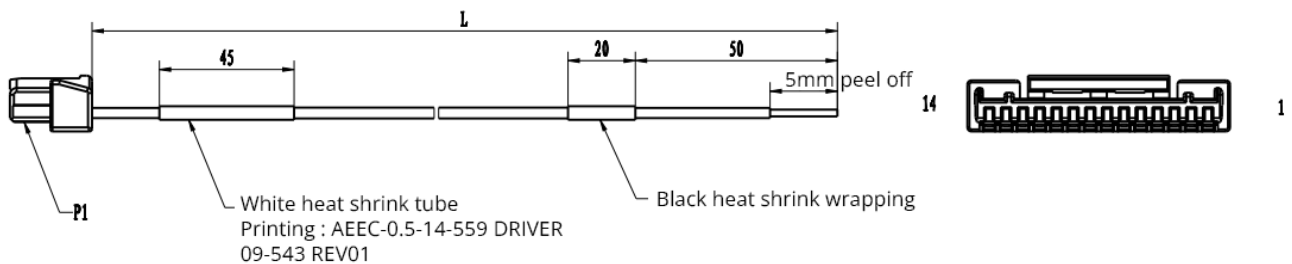

## Interface Definition

PIN	DS-BVM-FETC / DS-BVM-FCAO	Color
1	SIN+	pink
2	SIN-	pink gray
3	COS+	white
4	COS-	white gray
5	REF+	yellow
6	REF-	yellow gray
7	5V	red
8	GND	red gray
9	FG	blue
10	AHALL_U	blue gray
11	AHALL_V	green
12	AHALL_W	green gray
13	AIN+	purple
14	AIN-	purple gray

## (9) Communication cable-PC P11

Ordering Model	L (mm)	Item Number	Ver. Number
USB MINI	800	09-555	REV 00

Connector Model : USB-Mini Type B

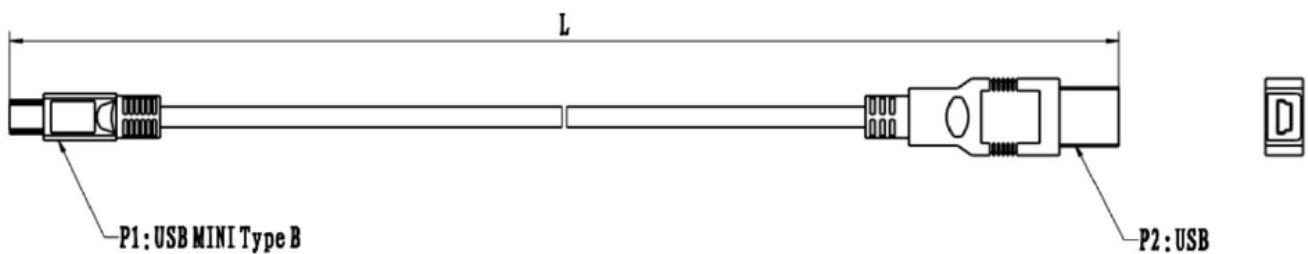



## 8. DS-CLS9-FETC

### 8.1 Dimensional Drawing

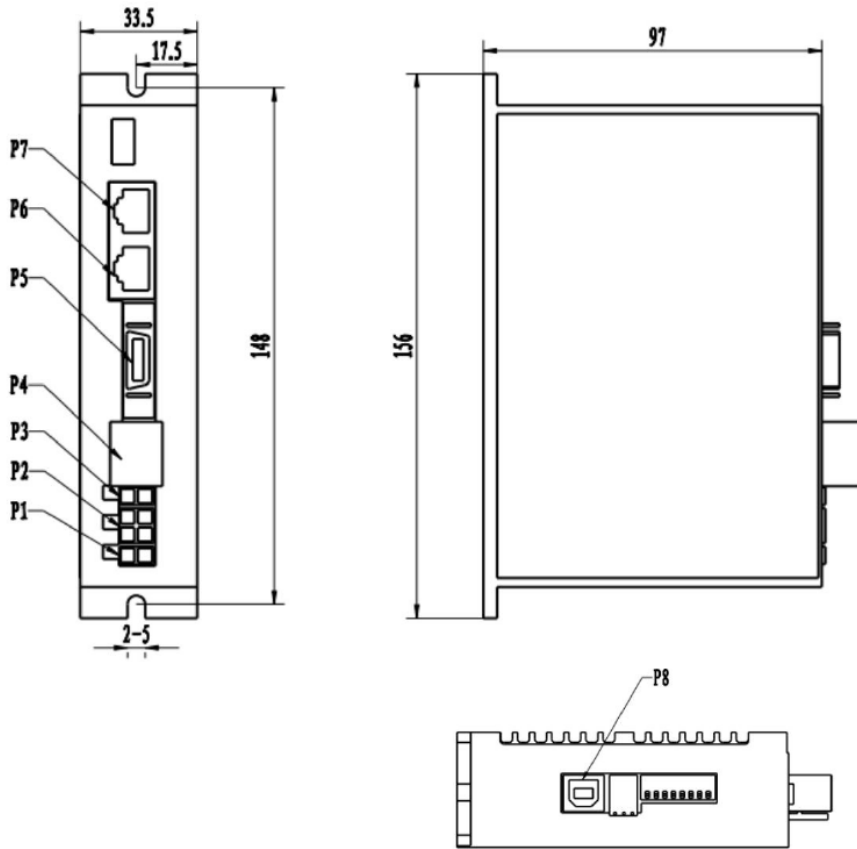

### 8.2 Accessories

#### (1) Power extension cable P1

Ordering Model	L (mm)	Item Number	Ver. Number
PEC-1.0-14.549	1000	09-531-1	REV 03
PEC-3.0-14.549	3000	09-531-2	REV 03
PEC-5.0-14.549	5000	09-531-3	REV 03

Connector Model : 5557-2\*1R, 5559-2\*1P

Wire harness: 0.5mm\*2, 200W sub-bending motion cable with drag chain

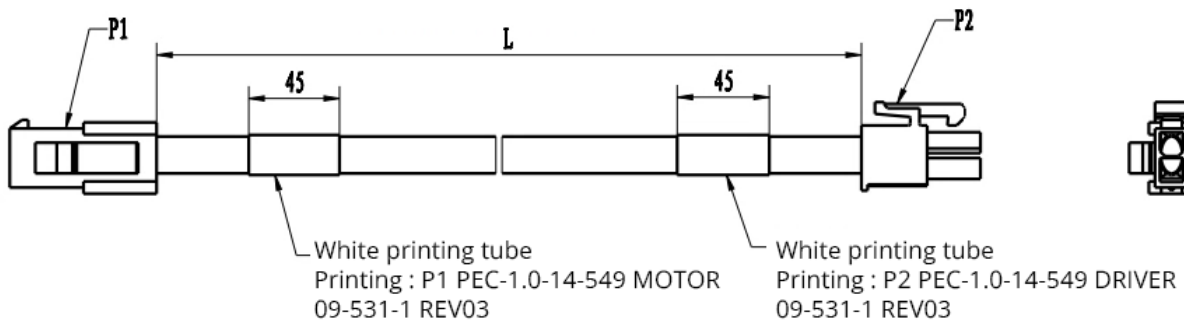

## Interface Definition

PIN	DS-CLS9-FETC	Color
1	GND	black
2	V+	red

## (2) Motor extension cable P2

Ordering Model	L (mm)	Item Number	Ver. Number
MEC-1.0-14.549	1000	09-532-1	REV 03
MEC-3.0-14.549	3000	09-532-2	REV 03
MEC-5.0-14.549	5000	09-532-3	REV 03

Connector model: 5557-2\*2R, 5559-2\*2P

Wire harness: 0.5mm\*4, 200W sub-bending motion cable with drag chain

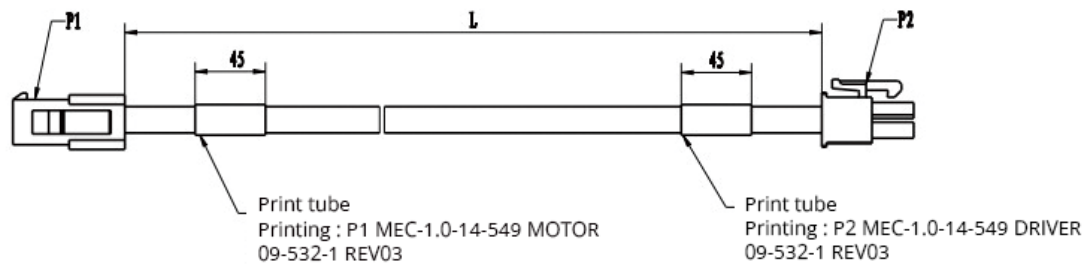

## Interface Definition

PIN	DS-CLS9-FETC	Color
1	B-	blue
2	A-	green
3	B+	red
4	A+	yellow

## (3) Brake extension cable P3

Ordering Model	L (mm)	Item Number	Ver. Number
BEC-1.0-14.549	1000	09-533-1	REV 03
BEC-3.0-14.549	3000	09-533-2	REV 03
BEC-5.0-14.549	5000	09-533-3	REV 03

Connector model: 5557-2\*1R, 5559-2\*1P

Wire harness: 0.5mm\*2, 200W sub-bending motion cable with drag chain

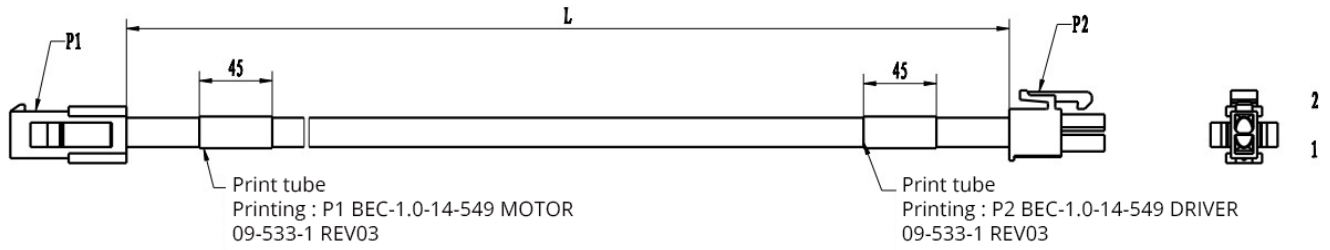

**Interface Definition**

PIN	DS-CLS9-FETC	Color
1	Break-	black
2	Break+	red

**(4) Encoder extension cable P4**

Ordering Model	L (mm)	Item Number	Ver. Number
EEC-1.0-14.418	1000	09-509	REV 03
EEC-3.0-14.418	3000	09-509-1	REV 03
EEC-5.0-14.418	5000	09-509-2	REV 03

Connector model: SMP-10V-NC

Wire harness: 5P\*26AWG, 200W sub-bending sports cable with drag chain. With shield

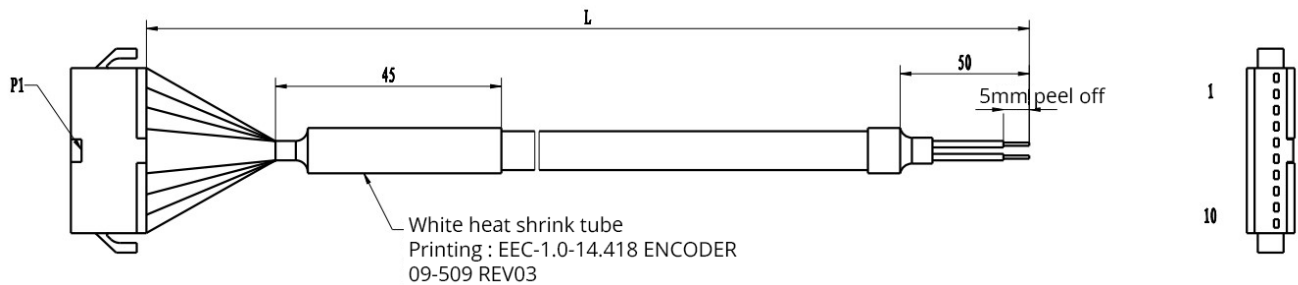

**Interface Definition**

PIN	DS-CLS9-FETC	Color
1	+5V	red
2	GND	black
3	A+	yellow
4	A-	yellow black
5	B+	green
6	B-	green black
7	Z+	blue
8	Z-	blue black
9	FG	black white
10	NC	red white

## (5) I/O extension cable P5

Ordering Model	L (mm)	Item Number	Ver. Number
IEC-1.0-14.549	1000	09-535-1	REV 00
IEC-3.0-14.549	3000	09-535-2	REV 00
IEC-5.0-14.549	5000	09-535-3	REV 00

Connector model: SCSI-20P

Wire harness: Inner core 10P\*26AWG, with shielding layer, supports 200W bending times, with drag chain

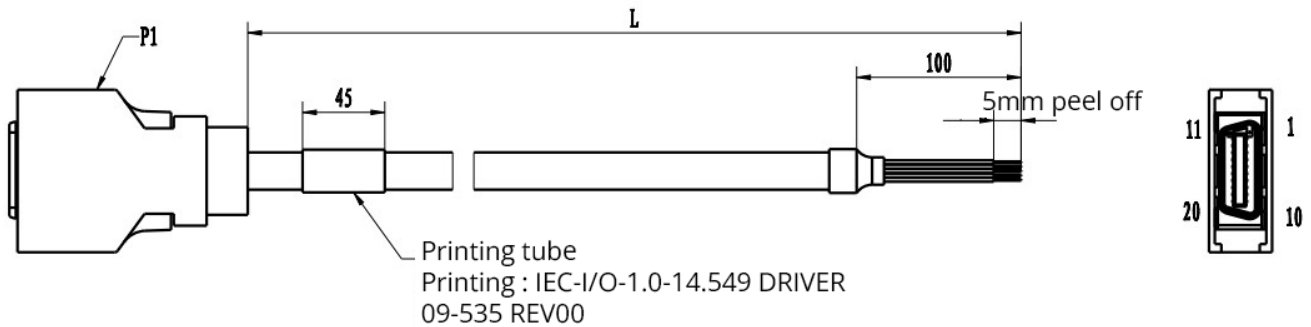

## Interface Definition

PIN	DS-CLS9-FETC	Color
1	COM (IN)	red
2	IN1	orange
3	IN2	purple
4	IN3	ash
5	IN4	Black white
6	IN5	gray black
7	IN6+	blue
8	IN6-	blue black
9	IN7+	green
10	IN7-	green black
11	OUT1	red white
12	OUT2	orange black
13	OUT3	purple black
14	COM (OUT)	black
15	Encoder A+	white
16	Encoder A-	white black
17	Encoder B+	yellow
18	Encoder B-	yellow black
19	Encoder Z+	brown
20	Encoder Z-	brown black

**(6) RJ45 communication cable ② to Driver P6 or P7**

Ordering Model	L (mm)	Item Number	Ver. Number
REC-0.15-14.418	150	09-512	REV 02
REC-0.3-14.418	300	09-512-1	REV 02
REC-1.0-14.418	1000	09-534-1	REV 01
REC-3.0-14.418	3000	09-534-2	REV 01
REC-5.0-14.418	5000	09-534-3	REV 01

Connector model: RJ45

Wire harness: TRVVSP curl-resistant 4p\*26AWG

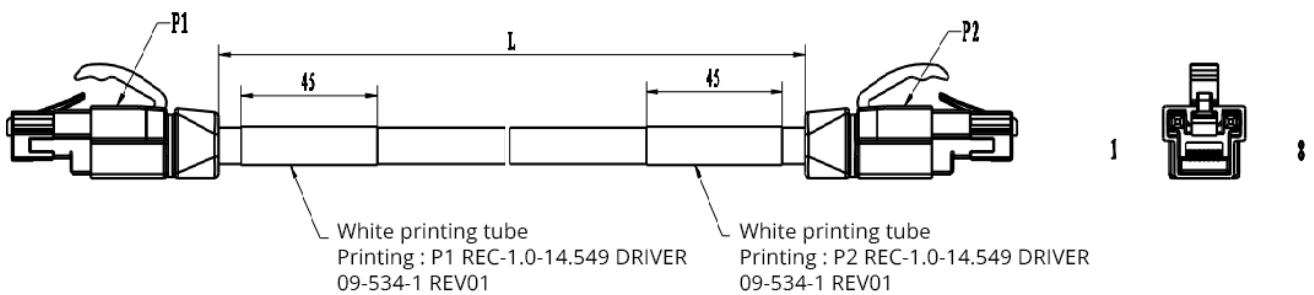

**Interface Definition**

PIN	DS-CLS9-FETC	Color
1	E-TX+	White green
2	E-TX-	green
3	E-RX+	white orange
4	NC	blue
5	NC	White blue
6	E-RX-	orange
7	CN5	white brown
8	CN5	brown

**(7) Communication cable-PC P8**

Ordering Model	L (mm)	Item Number	Ver. Number
USB-B communication cable	1000	09-563	REV 00

Connector Model : USB male, USB-B male plug

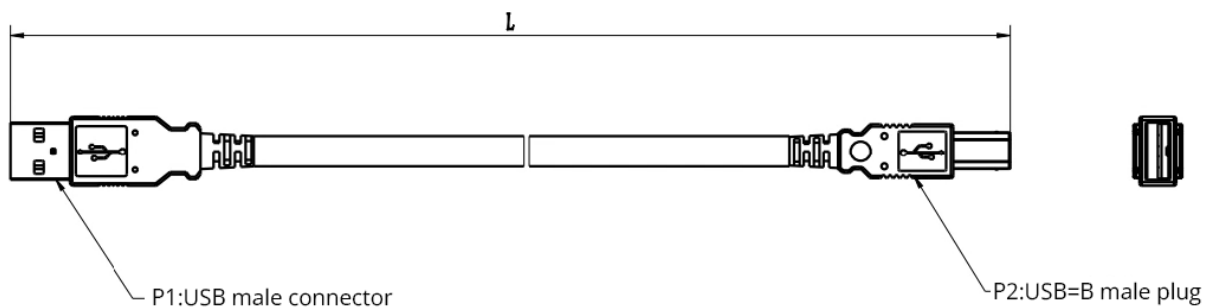

## 9. DS-CLS3-FETC-4I

### 9.1 Dimensional Drawing

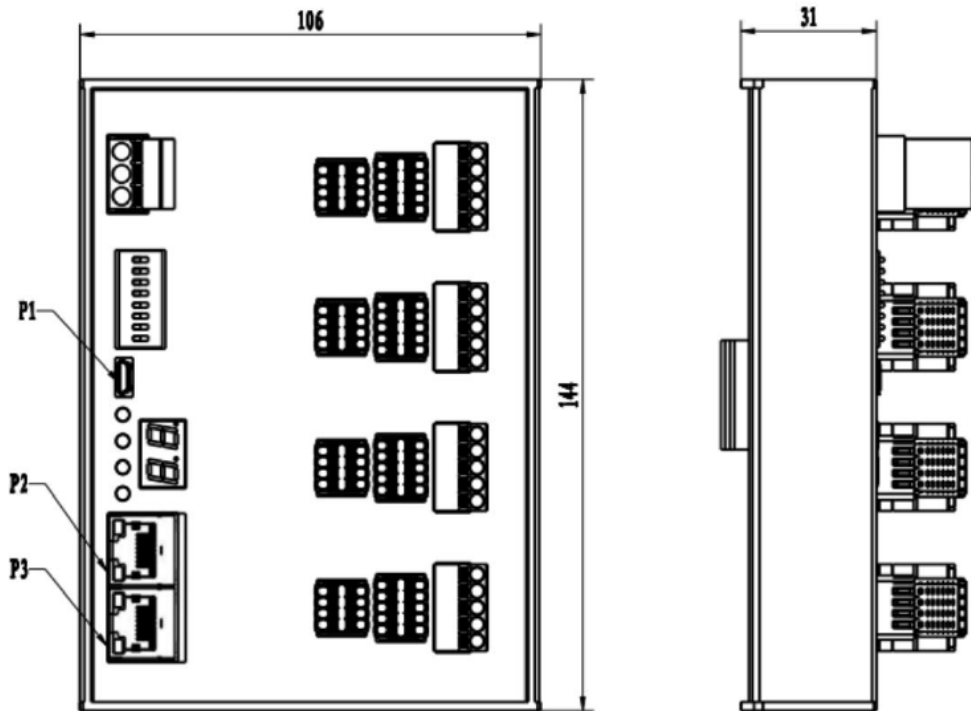

### 9.2 Accessories

#### (1) Communication cable-PC P1

Ordering Model	L (mm)	Item Number	Ver. Number
MicroUSB communication cable	1500	09-564	REV 00

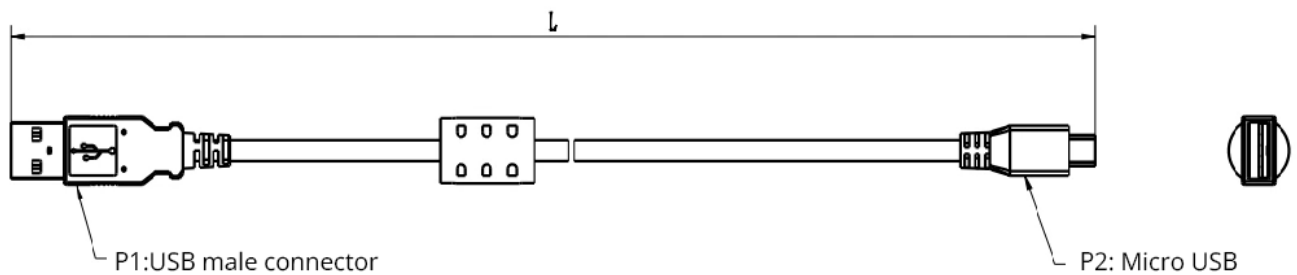

**(2) RJ45 communication cable ② to Driver P2 or P3**

Ordering Model	L (mm)	Item Number	Ver. Number
REC-0.15-14.418	150	09-512	REV 02
REC-0.3-14.418	300	09-512-1	REV 02
REC-1.0-14.549	1000	09-534-1	REV 01
REC-3.0-14.549	3000	09-534-2	REV 01
REC-5.0-14.549	5000	09-534-3	REV 01

Connector model: RJ45

Wire harness: TRVVSP curl-resistant 4p\*26AWG

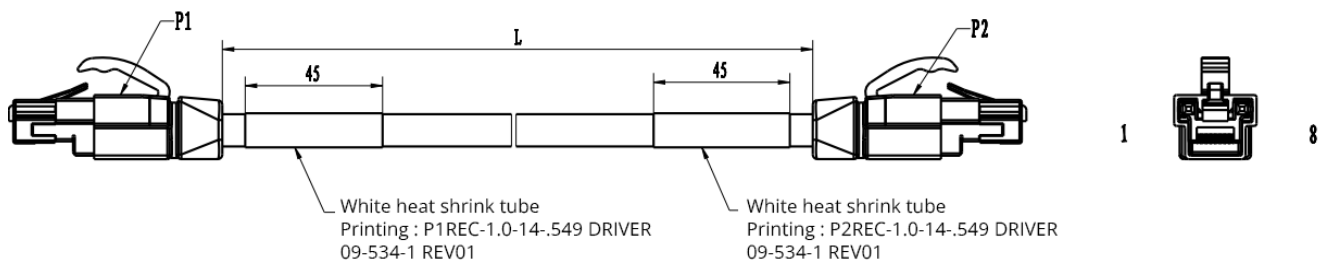

**Interface Definition**

PIN	DS-CLS3-FETC-4I	Color
1	E-TX+	white green
2	E-TX-	green
3	E-RX+	white orange
4	-	blue
5	-	white blue
6	E-RX-	orange
7	-	white brown
8	-	brown



+86-0519-8517 7825



+86-0519-8517 7807



No. 2850 Luheng Road, Changzhou Economic  
Development Zone, Jiangsu Province, China



[www.dingsmotion.com](http://www.dingsmotion.com)

## International Customer

Person in Charge :

*Daniel Jang*

[daniel@dingsmotion.com](mailto:daniel@dingsmotion.com)

No. 2850 Luheng Road, Changzhou  
Economic Development Zone,  
Jiangsu Province, China

+86-519-85177825, 85177826

## North America Customer

Person in Charge :

*Nicolas Ha*

[sales@dingsmotionusa.com](mailto:sales@dingsmotionusa.com)

335 Cochrane Circle Morgan Hill,  
CA 95037

+1-408-612-4970

## China Customer

Person in Charge :

*Sweet Shi*

[info@dingsmotion.com](mailto:info@dingsmotion.com)

No. 2850 Luheng Road, Changzhou  
Economic Development Zone,  
Jiangsu Province, China

+86-519-85177825, 85177826