

1

2

3

4

5

6

7

8

CHANGE

Revision

Date

Description

Approval

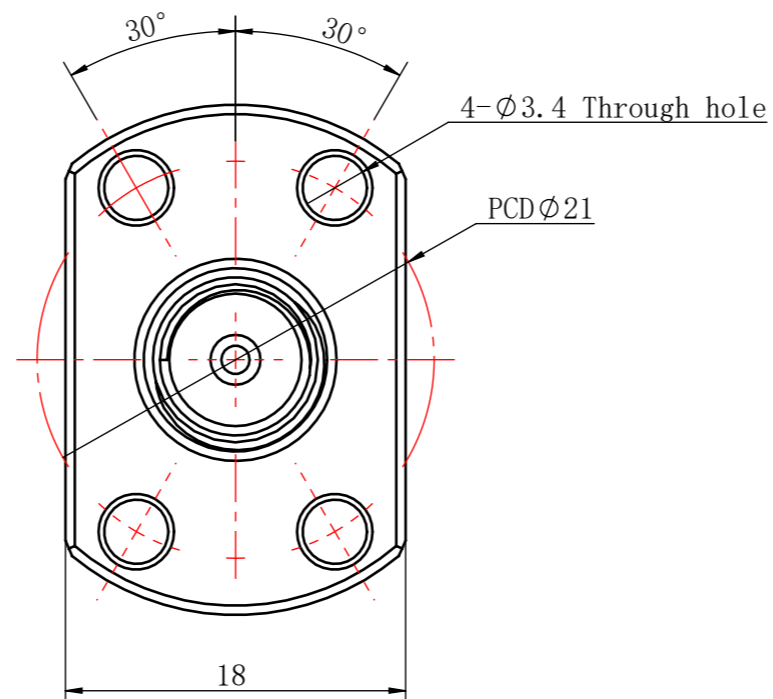
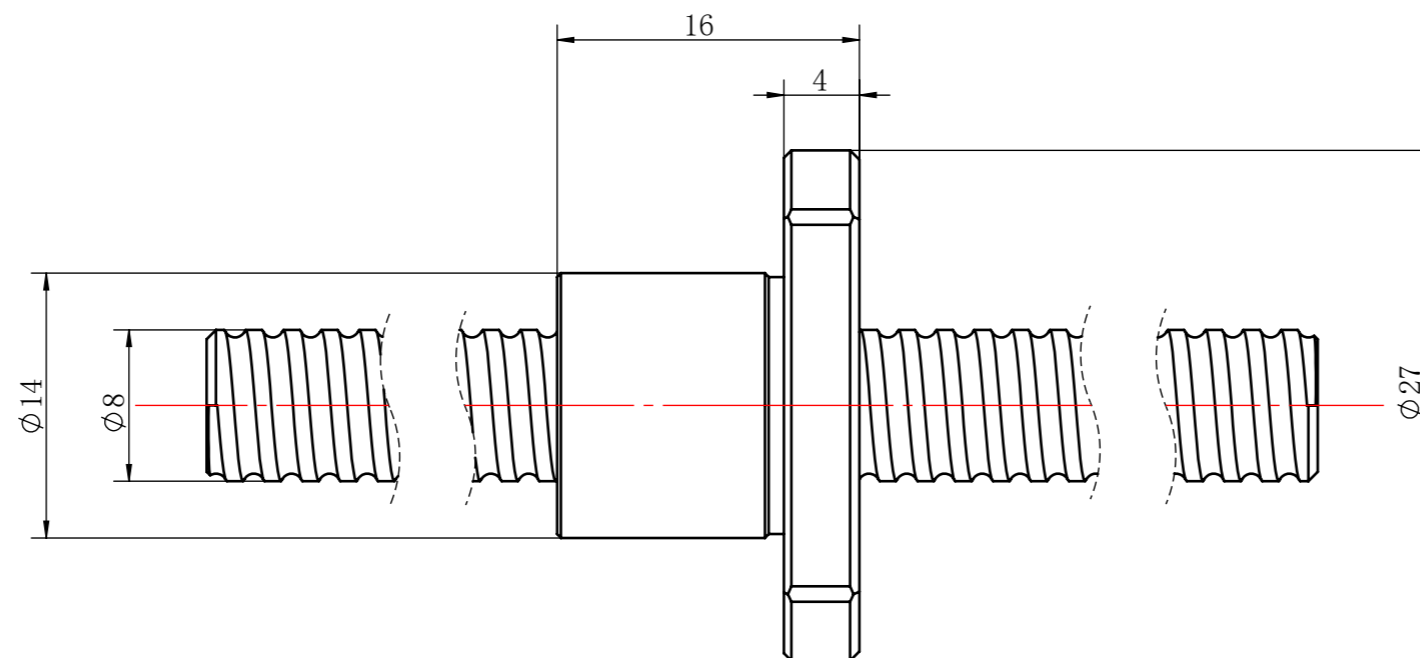

LINEAR		SPECIFICATION				CUSTOMER				
0.5~3	±0.1	B. C. D	Ø8.4	BALL SIZE	Ø1.2	C. MODLE				
>3~6	±0.1	SPACER BALL		LEAD	2	MODLE FBG0802				
>6~30	±0.2	ALLOW ROTATION NUMBER		LEAD ANGLE		NAME BALL SCREW				
>30~120	±0.3	LUBRICANT		NUMBER OF TURNSxROWS		WEIGHT				
>120~400	±0.5	O. C.	MAX. AXIAL Ca	THREAD DIRECTION/NUMBER OF THREAD		SCALE	DESIGN	REV.		
>400~1000	±0.8		MAX. RPM		DYNAMIC Ca (N)		CHECK	TOTAL:		
>1000~2000	±1.2	L. A.			STATIC Coa (N)	UNITS	RATIFY	PAGE:		
ANGULAR					PRELORD TORQUE			JIANGSU DINGS' INTELLIGENT CONTROL		
~10	±1°				AXIAL PLAY					
>10~50	±30'				SCREW MATERIAL					
>50~120	±20'				NUT MATERIAL					
>120~400	±10'	ACCURACY GRADE:								

1

2

3

4

5

6

7

8